

Fixings

Product Catalogue





Welcome to the latest edition of our Fixings Catalogue

Offering you a vast range of top quality, brand leading Fixings, supported by our nationwide branch network.

From screws and nails to anchors, adhesives, sealants and tapes – our Fixings branches have got everything you need for any project. Our branches also supply hand tools, power tools, safety clothing, and site equipment to help you get the job done.

We're part of the SIG group, which includes Insulation, Technical Insulation, Construction Accessories, Interiors, Mechanical and Electrical and Fixings businesses, meaning that you can source a huge range of products, all from your local SIG branches.



www.sigfixings.co.uk

Section	Page No.	Section	Page No.
General Fixings	4-13	Sealants & Adhesives	64-81
Lightweight Anchors	14-21	Tapes	82-85
Heavy Duty Anchors	22-25	Safety & Clothing	86-93
Nailings & Tools	26-31	Hand Tools	94-105
Power Tools	32-47	Site Equipment	106-123
Power Tool Accessories	48-63	Index	124-127



General Fixings

Our Brands



Products

Page No.

Drywall Screws	5
Collated Screws	6
Wood Screws	8
Coach Bolts	8
Concrete Screw	9
Machine Screws	9
Nails	10
Masonry Nails	11
Helical Fixings	11
Pins	12
Packers & Shims	12



Drywall Screws

Drywall Screw Fine Thread

Hardened steel Drywall Screw fine thread, bugle head, phillips, for fixing plasterboard to light gauge metal stud and track. Available in BZP and black phosphate.



Diameter (mm)	Length (mm)	Box
3.5	25, 32, 38, 42, 50	1000
4.2	65, 75	500
4.8	100	500

Drywall Screw Coarse Thread

Hardened steel Drywall Screw fine thread, bugle head, phillips and black phosphate, for fixing plasterboard to timber.



Diameter (mm)	Length (mm)	Pack Qty
3.5	25, 32, 38, 42, 50	1000
4.2	65, 75	500
4.8	100	500

Drywall Screw Self Drill

Self Drilling Drywall Screw Hardened steel, fine thread, bugle head, phillips, BZP for fixing plasterboard to metal stud and track over 0.9mm.



Diameter (mm)	Length (mm)	Pack Qty
3.5	25, 32, 38, 42, 50	1000
4.2	65, 75	500
4.8	100	500

Wafer Head Self Drill Screw

Low profile large diameter head for connecting heavy gauge metal components beneath plasterboard. Fixing metal over 0.8mm thick.



Diameter (mm)	Length (mm)	Pack Qty
4.2	13	1000

Collated Screw

Classic Collated

Autofeed screws for use in industrial areas with a moderate salt atmosphere. Suitable for hardwood, softwood, chipboard, MDF, thin metal and plastic

Colour:

Stainless Steel

Head:

Pozi



Diameter (mm)	Length (mm)	Pack Qty
4	40, 50	1000

Solo Collated

Autofeed screws for use in clean, dry and low humidity environments. Suitable for softwood, chipboard, MDF and thin metal.

Colour:

Yellow

Head:

Pozi



Diameter (mm)	Length (mm)	Pack Qty
4.2	40, 50, 55	1000
4.2	60, 70	500

Collated Flooring Screw

Autofeed screws for use in clean, dry and low humidity environments. Suitable for softwood.

Colour:

Yellow

Head:

Square



Diameter (mm)	Length (mm)	Pack Qty
4	40, 50	100

Collated Wingtip Self Drilling

Autofeed screws suitable for steel

Head:

Phillips

Product Variant

Exterior

For use in urban and industrial areas with low salt atmosphere.



Diameter (mm)	Length (mm)	Pack Qty
4.8	44	1000

Zinc

For use in clean, dry and low humidity environments.

Diameter (mm)	Length (mm)	Pack Qty
4.8	65	500

Collated Coarse Thread

Autofeed screws for use in clean, dry and low humidity environments. Suitable for plasterboard and softwood.

Colour:

Black PHOS

Head:

Phillips



Diameter (mm)	Length (mm)	Pack Qty
3.5	25, 32, 35, 38, 45, 50, 55	1000
4.2	65, 75	1000

Collated Fine Thread

Autofeed screws for use in clean, dry and low humidity environments. Suitable for plasterboard and thin metal.

Colour:

Zinc

Head:

Phillips



Diameter (mm)	Length (mm)	Pack Qty
3.5	25, 32, 35, 38, 45, 50, 55	1000



“
Speedline Drywall
Systems have been
designed and tested to
meet current regulations
for acoustic performance,
fire resistance, duty
ratings and thermal
efficiency.
”

BUILD YOUR NAME ON US

Speedline Drywall Systems

Available **exclusively** from SIG

Fundamental to the range is a comprehensive choice of Speedline metal profiles and components which form the basis of dry lining, partitioning, and ceiling systems. Speedline provides a full technical service with assistance on design, procurement and on-site project support.

Quality & Standards

Thanks to extensive research and development, combined with advanced manufacturing techniques, all Speedline Drywall System products conform to the latest British and European standards.

Nationwide Service

Speedline Drywall Systems are available exclusively from SIG branches throughout the UK. Branches carry extensive stocks of all products, plus a comprehensive choice of Speedline accessories, such as fixings, adhesives, joint compounds, tapes and sealants.

Experienced staff offer a fast and efficient service whilst product specialists are on hand to assist with technical issues and complex specifications.

For more information and to find your local stockist visit
www.speedlinedrywall.co.uk



INSULATION | INTERIORS | TECHNICAL INSULATION
FIXINGS | CONSTRUCTION ACCESSORIES | COMMERCIAL DRAINAGE



SPEEDLINE
DRYWALL SYSTEMS | Part of SIG plc

Wood Screws

Twin Thread Woodscrew

A traditional sharp point screw with a twin-thread for a fast installation. Soft timber application.

Product Variant:

BZP, Yellow Passivated



Gauge (mm)	Length (in)	Pack Qty
4	1/2, 5/8, 3/4, 1	200
5	1/2, 5/8	200
6	1/2, 5/8, 3/4, 1, 1 1/4, 1 1/2, 1 3/4, 2	200
7	3/4, 1, 1 1/4, 1 1/2	200
8	1/2, 5/8, 3/4, 1, 1 1/4, 1 1/2, 1 3/4, 2, 2 1/4, 2 1/2, 3	200
10	3/4, 1, 1 1/4, 1 1/2, 1 3/4, 2, 2 1/4, 2 1/2, 3, 3 1/2, 4	100/200
12	1 1/4, 1 1/2, 2, 2 1/2, 3, 3 1/2, 4	100

Multi-purpose Chipboard Screws

Multi-purpose screw suitable for hardwood, chipboard, MDF, plastic and thin sheet metal.

Product Variant:

BZP, Yellow Passivated



Diameter (mm)	Length (mm)	Pack Qty
3.5	25, 30, 35, 40, 45, 50	200
4.0	20, 25, 30, 35, 40, 45, 50, 55, 60, 70, 80	200
4.5	30, 45	200
5.0	30, 40, 45, 50, 60, 70, 80, 100	200
5.0	100	100
6.0	100, 120	100

Coach Bolts

Coach Bolts

A heavy duty bolt used for fastening timbers. It has an impact resistant dome head and the square under the head locks into the timber to stop the bolt from spinning.



Diameter (mm)	Length (mm)	Pack Qty
10	100, 150, 160, 200, 220	10

Concrete Screw

Concrete Screw

A rapid and effective light duty anchoring system for fixing into concrete, brick, stone, concrete block and wood.

Replaces traditional fixings such as nylon frame and hammer fixings.

Product Variant

Countersunk

Colour:

Yellow

Head:

Cylindrical Head + Hex Head Drive

Diameter (mm)	Length (mm)	Pack Qty
7.5	40, 60, 80, 100, 120, 150, 180	100

Pan head

Colour:

Zinc

Head:

Cylindrical Head + Hex Head Drive

Diameter (mm)	Length (mm)	Pack Qty
7.5	40, 60, 80, 100, 120, 150, 180	100



Machine Screws

Machine Screws

Used to attach window or door furniture to a pre-threaded back plate, with a countersunk head, a metric thread and a B point tip.



Diameter (mm)	Length (mm)	Pack Qty
M5	20, 30, 40, 50	500

Hex Head Multifix Screw

This one piece fixing is suitable for most substrate materials.



Diameter (mm)	Length (mm)	Pack Qty
6	50, 75, 100, 130	100
6	150	75
8	60, 75, 100	100
8	100, 130, 150	50
10	60, 75, 100, 130, 150	50
10	150	25
12	60	50
12	75, 100, 130, 150	25
16	10, 150	10

Nails

Annular Ring

Grooved nail for excellent grip into timber used in most building applications where extra strength is required. 20mm and 25mm are especially used in flooring applications.



Different Finishes Available

Diameter (mm)	Length (mm)	Box Size
2.00	20, 25	500g to 25kg
2.36	30	500g to 25kg
2.65	40, 50	500g to 25kg
3.35	50, 65	500g to 25kg
3.75	75	500g to 25kg
5.00	100, 125	500g to 25kg

Round Wire

General purpose nails used for a variety of applications.

Large round head nails are suitable for carpentry where strength is essential.



Different Finishes Available

Diameter (mm)	Length (mm)	Box Size
1.80	25	500g to 25kg
2.36	30, 40	500g to 25kg
2.65	40, 50, 65	500g to 25kg
3.35	50, 65, 75	500g to 25kg
3.75	75	500g to 25kg
4.00	100	500g to 25kg
4.50	100	500g to 25kg
5.60	125	500g to 25kg
6.00	150	500g to 25kg

ELH Clout

Galvanised Extra Large Head clout nails used for general purpose and securing roof felt and slate tiles.



Different Finishes Available

Diameter (mm)	Length (mm)	Box Size
3.00	13, 15, 20, 25, 30, 40, 50	500g to 25kg

Clout Nails

Galvanised for weather protection. Clout nails are used for securing roof tiles and slates.



Different Finishes Available

Diameter (mm)	Length (mm)	Box Size
2.65	20, 25, 30, 40, 50, 65	500g to 25kg
3.35	40, 50	500g to 25kg
3.75	65, 75	500g to 25kg
4.50	100	500g to 25kg

Square Twist

For use with joist hangers and restraint straps. They can also be used for external cladding or felt.



Different Finishes Available

Diameter (mm)	Length (mm)	Box Size
3.75	30, 40	500g to 25kg

Masonry Nails

Masonry Nails

Suitable for fixing into brick, block and concrete. Available in light, medium and heavy gauge.



Diameter (mm)	Length (mm)	Pack Qty
2.5	25, 30, 35, 40, 50	100
3.0	25, 30, 35, 40, 50, 60, 70, 80	100

Mickey Pins

Washed masonry nail. Suitable for fixing into brick, block and concrete.



Length (mm)	Pack Qty
30	200

Helical Fixings

Insulation Fixing

A Helical fixing that is used to secure and sandwich a layer of insulation over the structural roofing timbers in energy efficient buildings.



Diameter (mm)	Length (mm)
4.5	50-1000
6	50-1000
7	50-1000
8	50-1000
9	50-1000
10	50-1000

Composite Panel Fixing

Composite Panel Fixing – Hammer driven fixing for securing structural 6 mm plywood composite insulation board to flat roofs. No drilling.



Diameter (mm)	Length (mm)	Suitable Panel Sizes
TC8	90	Up to 55mm
TC8	135	70-96mm
TC8	165	96-126mm
TC8	195	126-156mm
TC8	220	150-185mm

Pins

Panel Pins

A light thin nail with a small head suitable for fixing the backs of wardrobes and cupboards.



Diameter (mm)	Length (mm)	Pack Qty
1.4	20	500g – 2.5kg
1.6	30, 40	500g – 2.5kg
2.0	50	500g – 2.5kg

Packers & Shims

Packers & Shims

Product Variant:

Available in different sizes and pack quantities.



Blue 60 Fire Rated Frame Foam

Specially formulated expanding foam that when used in conjunction with fire rated packers gives upto 60 minutes fire protection to timber doorsets without the use of additional mastics or sealants.

30 & 60 minute fire tested to BS-EN 1634-1 & BS476-22

Fire Rated Packers

Colour co-ordinated fire rated packers

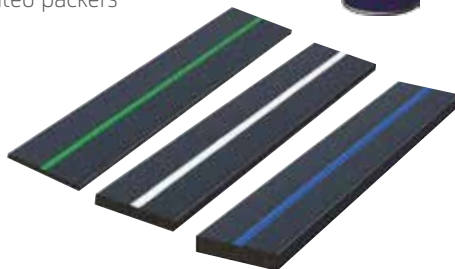

Colour	Size (mm)
Green	1 x 15 x 100
White	3 x 15 x 100
Blue	5 x 15 x 100

SENCO[®]

THE UK'S NO.1 SUPPLIER OF AUTO-FEED SCREWDRIVERS & COLLATED SCREWS

All CE-approved (conforming to EN14566)



- A complete range of collated screws in lengths 19-75mm
- Drywall to wood
- Drywall to light steel
- Drywall to heavy steel
- Wafer head for metal applications

DURASPIN[®]
TECHNOLOGY

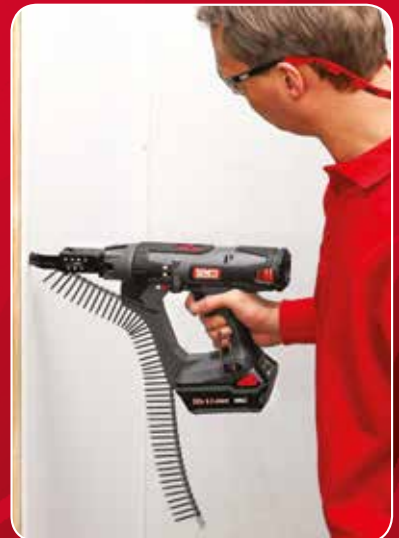

WWW.SENCO.EU

MAKING HARD WORK
EASIER

Lightweight Anchors

Our Brands



Products

Page No.

Hammer Fixings

15

Self-Drill Plasterboard Fixings

15

Insulation Fixings

16

Tek Screws

17

Other Fixings

19-20

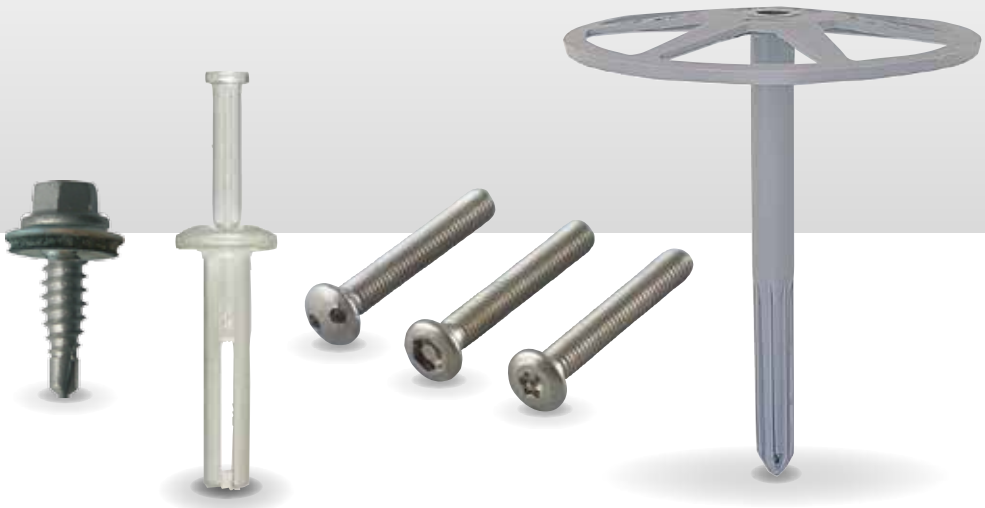

Hammer Fixings

Nylon Hammer Screws

Pre-assembled nylon hammer fixings for quick and easy fixing into concrete and solid masonry.



Diameter (mm)	Length (mm)	Pack Qty
5	30	100
6	40, 50, 60, 80	100
8	60, 80, 100, 120	50

Metal Nail In

Lightweight through fixing for use in concrete, solid brickwork and stone. Not recommended for overhead applications such as suspended ceilings.



Diameter (mm)	Length (mm)	Pack Qty
6	30, 40, 50, 60	200

Self-Drill Plasterboard Fixings

Driva

The original and best self-drilling plasterboard fixing. Quick and easy to install using only a screwdriver.

Good pull-out values with efficient dust disposal.



Description	Diameter (mm)	Pack Qty
TP12	25	100
TF277	50	100
TF5	25	100
F12*	35	100

TP = Pan Head

TF = Countersunk

*For pre-drilling into aerated concrete

Insulation Fixings

Insulation Hangers

Metal insulation hangers provide instant mechanical fixing of pre-formed insulation material to various surfaces.

Self adhesive with washer.



Length (mm)	Pack Qty
62	200
100	100

Plastic Insulation Support DHK

Cost effective plastic insulation support for all conventional insulation boards.



Usable Length (mm)	Fixing Length (mm)
20 - 40	70
40 - 60	90
60 - 80	110
80 - 100	130
110 - 120	150
120 - 140	170
140 - 160	190

Metal Insulation Support DHM

The fire-protection-tested metal insulation support for fire-resistant insulating boards.



Usable Length (mm)	Fixing Length (mm)
10 - 40	80
40 - 70	110
70 - 100	140
100 - 130	170
130 - 160	200
170 - 210	250
220 - 260	300

Frame Fixings

Available in various sizes, finishes and head styles.



Diameter Available	Length Available
M6	60MM
M8	60MM, 80MM, 100MM & 120MM
M10	80MM, 100MM, 120MM, 140MM & 160MM

Tek Screws

Light Gauge Tek Screw

Bonded Hex Washer Head Tek 3
– For 1.2mm-3.5mm Steel

Application:

Fixing cladding and roofing applications to hot and cold rolled purlins/rail

Product Variant:

Carbon Steel, Stainless Steel



Diameter (mm)	Length (mm)	Pack Qty
5.5	26, 32, 38	250
5.5	50, 60, 75, 100	100

Composite Panel Screw

High Thread Bonded Hex Washer Head Tek 3 – For 1.2mm-3.5mm Steel

Application:

Fixing cladding and roofing applications to hot and cold rolled purlins/rail. Fastening liner panels and general components to steel.

Product Variant:

Carbon Steel, Stainless Steel



Diameter (mm)	Length (mm)	Pack Qty
6.3	80, 105, 135, 150, 185, 225	100

Timber Fix

For fixing timber or composites to steel

Product Variant:

Carbon Steel, Stainless Steel



Diameter (mm)	Length (mm)	Pack Qty
4.2	38	200
4.8	45	100
5.5	50, 62	200
5.5	80, 100, 120, 150, 180	100

Stitching Screws

For stitching cladding panels

Product Variant:

Carbon Steel, Zinc Coating, Bi-metal

With or without washer



Diameter (mm)	Length (mm)	Pack Qty
6.3	22	200

SuperTek

For fixing steel to steel

Available with or without washer



Diameter (mm)	Length (mm)	Pack Qty
5.5	50	100

FOR ALL YOUR TEK SCREWS, ASK FOR

evolution

Evolution Fasteners Ltd have the widest range of self-drilling, tek screws designed for fixing to steel as well as gash point tek screws for fixing to timber.

Evolution tek screws are available with zinc coating, salt spray coating or in stainless steel/ bi-metal for ultimate corrosion resistance.

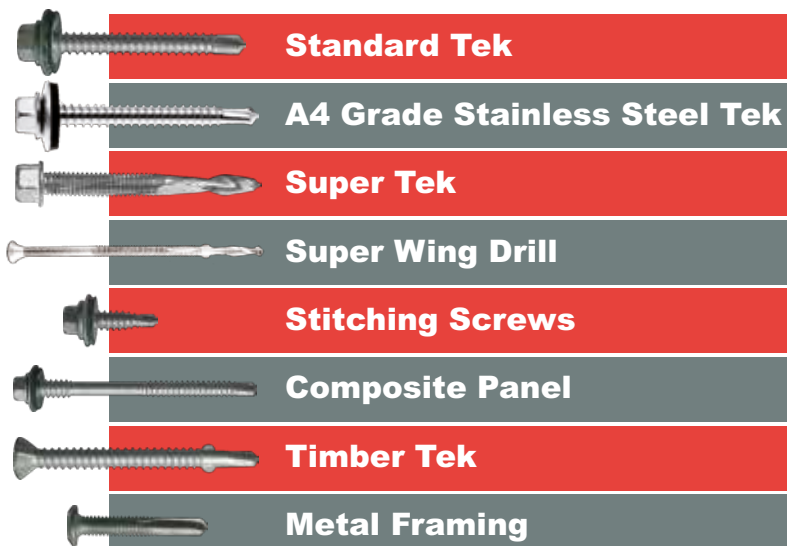

+ MORE

Other Fixings

Drop-in Anchors

Internally threaded concrete anchors for bolts and threaded rod.



Diameter (mm)	Pack Qty
6	100
8	100
10	100
12	50
16	20

Spring Toggles

It is ideal for ceiling installations. It can be used in single or double thickness plasterboard.



Diameter (mm)	Length (mm)	Pack Size
18	48	100

Wire Hanger

Mild steel zinc & yellow passivate for suspension by wire rope, single strand wire and strap.



Diameter (mm)	Length (mm)	Box Quantity
6, 8, 10	60, 80, 100	100

Plastic Plugs

Suitable for all kinds of concrete and masonry substrate materials.

Available Colours:
Yellow, Red, Brown and Blue



Skirting Screws

Flange head self tapping screws.

Available Colours:
BZR, White, Grey and Black.



Diameter (mm)	Length (mm)	Pack Qty
3.5	25, 32, 38, 45, 51	1000

Other Fixings

Security Screws

Large range of tamper-resistant screws, bolts and nuts. Available in various sizes, finishes and head styles.



Decking Screws

Corrosion resistant, self-tapping sharp point screws for wood application. Available in a wide range of sizes and finishes



Rivets

We have a wide range of rivets available in different sizes and finishes.



Tapcon

The original masonry fastening tek screw system that cuts it's own thread into concrete, brick and block. Philips CSK head and Slotted washered hex head available.

Other Tapcon Accessories available.



Countersunk

Diameter (mm)	Length (mm)	Pack Qty
4	32, 45, 70, 82	100
5	45, 57, 70, 82, 100, 125	100

Hex Head

Diameter (mm)	Length (mm)	Pack Qty
4	32, 45, 70, 82	100
5	45, 57, 70, 82, 100, 125	100



Faster Steel Connections

For over 80 years Lindapter has pioneered the design and manufacture of steel clamping systems by providing a faster alternative to drilling or welding, saving contractors' time and money.



Decking Fixings

High quality, cost-effective steelwork connections for building services, which are designed to fit inside the dovetail re-entrant channel of major decking profiles. This zero-impact method avoids delamination and damage to the decking.



Support Fixings

Easy-to-install solutions for supporting building services such as HVAC equipment, pipework and sprinkler systems from structural or secondary beams. Their adjustability allows a fast and precise alignment during installation.



Girder Clamp



Hollo-Bolt[®]



Rail Fixings



Lifting Points

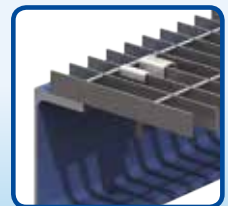

Floor Fixings

DISCOVER THE FULL PRODUCT RANGE

Contact Lindapter for a copy of the new product catalogue!



Heavy Duty Anchors

Our Brands



Products

Page No.

Products	Page No.
Anchors	23
Resin & Resin Studs	25
Through Bolts	25
Multi-Fix Bolts	25



Shield Anchors

Recommended for applications requiring fire resistance. Three-piece expanding sleeve of maximum expansion provides optimal load and safety of use in any substrate.

Various options available:

The sizes stated are for R-RB option.



Product Variant	Length (mm)	Pack Qty
M6	45	100
M8	50	100
M10	60	100
M12	75	50
M16	115	25
M20	130	15
M24	150	5

Sleeve Anchors

All purpose expansion anchor for use in low weight applications in non-cracked concrete. It is a through fixing, thus allowing the hole in the substrate to be drilled through the pre-positioned fixture, eliminating the need for marking out, ensuring fast and simple installation.



Countersunk		
Product Variant	Length (mm)	Pack Qty
M5	53, 80	100

Loose Bolt		
Product Variant	Length (mm)	Pack Qty
M8	60, 80	50
M10	70, 100	25

Bolt Projecting		
Product Variant	Length (mm)	Pack Qty
M5	56	100
M6	40	100
M6	65	50
M8	50, 75	50
M8	95	25
M10	60, 70	25
M10	100, 130	10
M12	110, 145	10

More power.

More intelligence.

The fischer DUO-Line range of products combine different materials and functions in a very clever way. Depending on the building material, the DUOTEC toggle and DUOPOWER plug automatically activate the best fixing functions for optimum loads.

One of many intelligent fastening solutions from fischer!



The innovative product line with

- More functions
- More performance
- More security



fischer fixings

Proud Partner of SIG

fischer fixings offers a comprehensive range of construction fixings covering practically all construction applications where a fixing is required. From high performance, specialist steel and chemical anchoring systems to interior fixings and high performance nylon plugs, fischer have the fixing for you.

Innovation

Thanks to a vast wealth of manufacturing knowledge within our internal R&D department, fischer is always at the forefront of innovation. The company strives to make new products more suitable for the installer with higher load performances and faster installation times.

A Global Business local to you

fischer fixings operates on a global scale with over 43 subsidiaries worldwide. The manufacturing side of the company along with R&D, fischer consulting and global procurement is all based in Germany however no matter how big fischer grows it will always retain the feel of a home-based local business. With an external team consisting of over 30 dedicated sales managers, local field engineers and a line-up of highly trained technical managers located across the UK, fischer is always able to offer highly efficient help and support wherever its needed. For more specialised advice our SBU managers are available to discuss the following topics - EW1, FireStop and A.C.T.

EXPERIENCED · KNOWLEDGEABLE · DEDICATED

The fischer external team is one of the very best in the industry and is always on willing to offer help and advice. For more information ask in branch today



Resin & Resin Studs

Resin Studs

Studs available in various sizes and finishes. Cut-to-size option available.



Resin

Wide range for resins from Basic Resins to High Performance Resins. Capsules and various cartridge sizes available.

*Polyester resins have NO approval for Masonry

Product Variant:

Polyester, Hybrid Polyester, Vinylester, Hybrid Vinylester, Epoxy



Through Bolts

Through Bolts

We have a wide range of throughbolts suitable for cracked and none-cracked concrete. Stainless Steel and Hot Dipped Galv also available



Multi-Fix Bolts

Multi-Fix Masonry Bolts

Stress free, non-expansion through fixing is the new solution for heavy duty anchoring into concrete, brick, stone, wood and concrete block.



Product Variant

Countersunk Head

Diameter	Length (mm)	Pack Qty
8	60, 75	100
8	100	50
10	60, 75, 100	50

Pan Head

Diameter	Length (mm)	Pack Qty
8	60, 75	100
8	100	50
10	60, 75, 100	50

Nailing & Tools

Our Brands



Products

Page No.

Nailers

27

Pulsa

27

Stapler

28

Shot fired Tools

28

Nails & Fuel Packs

28-30



Nailers

Paslode IM350+ Li-ion Gas Framing Nailer

Lithium cordless framing nailer for first fix timber to timber applications.

**Paslode IM360Ci Gas Framing Nailer**

Lithium cordless framing nailer for first fix timber to timber applications

**Paslode IM65 Brad Nailer**

Lithium cordless straight brad nailer.

**Paslode IM65A Brad Nailer**

Lithium cordless angled brad nailer.

**PPN35Ci Li-ion Positive Placement Nailer**

Lithium cordless positive placement nailer for installing hangers, brackets & straps.



Pulsa

Pulsa 800E Cordless Gas Nailer

Li-ion cordless gas nailer for fixing electrical cable management to steel and concrete.

**Pulsa 800P+ Cordless Gas Nailer**

Li-ion cordless gas nailer for fixing drywall track to steel and concrete.



Stapler

Paslode Impulse IM200/50 S16 Gas Stapler

Heavy duty cordless stapler is used for medium to heavy duty stapling applications into wood and plastic



Shot Fired Tools

Spitfire P370 Powder Actuated Disc Cartridge Tool

The professional's choice for shot fired fixings into steel, concrete and masonry.



Nails & Fuel Packs

Nail Fuel Packs to Suit IM350



Indoors – Eurocode 5 Service Class 1

Product Variant	Sizes (mm)	Pack Qty
Bright ring shank	2.8 x 51, 63	3300 + 3 fuel cells
Bright ring shank	3.1 x 75	2200 + 2 fuel cells
Bright smooth shank	3.1 x 90	2200 + 2 fuel cells

Indoors not heated, outdoors protected – Eurocode 5 Service Class 2

Product Variant	Sizes (mm)	Pack Qty
Galv Plus ring shank	2.8 x 51, 63	1100 + 1 fuel cell
Galv Plus ring shank	2.8 x 51, 63	3300 + 3 fuel cells
Galv Plus ring shank	3.1 x 63	1100 + 1 fuel cell
Galv Plus ring shank	3.1 x 63, 75	2200 + 2 fuel cells
Galv Plus smooth shank	3.1 x 90	2200 + 2 fuel cells

Outdoors, exposed to weather – Eurocode 5 Service Class 3

Product Variant	Sizes (mm)	Pack Qty
HDGV Ring shank	2.8 x 51, 63	3300 + 3 fuel cells
HDGV Ring shank	2.8 x 63	1100 + 1 fuel cell
HDGV Ring shank	2.8 x 63	2200 + 2 fuel cells
HDGV Ring shank	3.1 x 75	1100 + 1 fuel cell
HDGV Ring shank	3.1 x 75	2200 + 2 fuel cells
HDGV smooth shank	3.1 x 90	1100 + 1 fuel cell
HDGV smooth shank	3.1 x 90	2200 + 2 fuel cells
SS ring shank	2.8 x 51, 63	1100 + 1 fuel cell
SS ring shank	3.1 x 80	1100 + 1 fuel cell

Nail fuel Packs to Suit IM360



Indoors – Eurocode 5 Service Class 1

Product Variant	Sizes (mm)	Pack Qty
Bright ring shank	2.8 x 51, 63	3750 + 3 fuel cells
Bright ring shank	2.8 x 75	2500 + 2 fuel cells
Bright smooth shank	3.1 x 90	2500 + 2 fuel cells
Bright ring shank	3.1 x 90	2500 + 2 fuel cells

Indoors not heated, outdoors protected – Eurocode 5 Service Class 2

Product Variant	Sizes (mm)	Pack Qty
Galv Plus ring shank	2.8 x 51, 63	3750 + 3 fuel cells
Galv Plus ring shank	2.8 x 51, 63	1250 + 1 fuel cell
Galv Plus ring shank	3.1 x 63, 75, 90	2500 + 2 fuel cells
Galv Plus smooth shank	3.1 x 90	2500 + 2 fuel cells
Galv Plus smooth shank	3.1 x 90	1250 + 1 fuel cell

Outdoors, exposed to weather – Eurocode 5 Service Class 3

Product Variant	Sizes (mm)	Pack Qty
HDGV ring shank	2.8 x 63	3750 + 3 fuel cells
HDGV ring shank	3.1 x 63, 75, 90	2500 + 2 fuel cells
HDGV smooth shank	3.1 x 90	2500 + 2 fuel cells
SS ring shank	2.8 x 51, 63	1250 + 1 fuel cell
SS ring shank	3.1 x 80	1250 + 1 fuel cell
SS ring shank	2.8 x 51, 63	1100 + 1 fuel cell
SS ring shank	3.1 x 80	1100 + 1 fuel cell

Nails & Fuel Packs

Nail Fuel Packs to Suit IM65

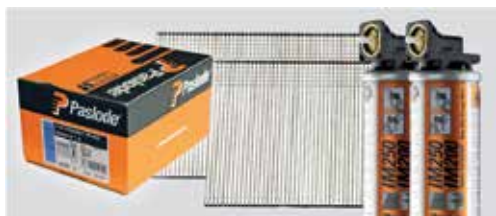

Indoors

Product Variant	Sizes (mm)	Pack Qty
Electro Galvanised	1.6 x 16	2000 + 2 fuel cells
Electro Galvanised	1.6 x 19	2000 + 2 fuel cells
Electro Galvanised	1.6 x 25	2000 + 2 fuel cells
Electro Galvanised	1.6 x 32	2000 + 2 fuel cells
Electro Galvanised	1.6 x 38	2000 + 2 fuel cells
Electro Galvanised	1.6 x 45	2000 + 2 fuel cells
Electro Galvanised	1.6 x 50	2000 + 2 fuel cells
Electro Galvanised	1.6 x 63	2000 + 2 fuel cells

Outdoors, exposed to weather

Product Variant	Sizes (mm)	Pack Qty
Stainless Steel A2-304	1.6 x 25	2000 + 2 fuel cells
Stainless Steel A2-304	1.6 x 38	2000 + 2 fuel cells
Stainless Steel A2-304	1.6 x 50	2000 + 2 fuel cells
Stainless Steel A2-304	1.6 x 63	2000 + 2 fuel cells

Nail Fuel Packs to Suit PPN35Ci



Indoors not heated, outdoors protected.

Product Variant	Sizes (mm)	Pack Qty
Twisted Electro Galvanised	3.4 x 35	1250
Twisted Electro Galvanised	3.4 x 35	2500

Nail Fuel Packs to Suit IM65A



Indoors

Product Variant	Sizes (mm)	Pack Qty
Electro Galvanised	1.6 x 16	2000 + 2 fuel cells
Electro Galvanised	1.6 x 19	2000 + 2 fuel cells
Electro Galvanised	1.6 x 25	2000 + 2 fuel cells
Electro Galvanised	1.6 x 32	2000 + 2 fuel cells
Electro Galvanised	1.6 x 38	2000 + 2 fuel cells
Electro Galvanised	1.6 x 45	2000 + 2 fuel cells
Electro Galvanised	1.6 x 50	2000 + 2 fuel cells
Electro Galvanised	1.6 x 63	2000 + 2 fuel cells

Outdoors, exposed to weather

Product Variant	Sizes (mm)	Pack Qty
Stainless Steel A2-304	1.6 x 25	2000 + 2 fuel cells
Stainless Steel A2-304	1.6 x 38	2000 + 2 fuel cells
Stainless Steel A2-304	1.6 x 50	2000 + 2 fuel cells
Stainless Steel A2-304	1.6 x 63	2000 + 2 fuel cells

Nails & Fuel Packs

Staple Fuel Packs to Suit IM200



Indoors – Service Class 1

Product Variant	Sizes (mm)	Pack Qty
Electro Galvanised	1.6 x 19 Chisel Point	3000 + 3 fuel cells
Electro Galvanised	1.6 x 25 Divergent Point	3000 + 3 fuel cells
Electro Galvanised	1.6 x 35 Chisel Point	3000 + 3 fuel cells
Electro Galvanised	1.6 x 50 Chisel Point	3000 + 3 fuel cells
Electro Galvanised	3,1 x 90	2500 + 2 fuel cells

Pins to Suit Pulsa 800P+



C6 Pins - Standard Concrete (C25)

Product Variant	Sizes (mm)	Pack Qty
Black	20, 25, 30, 35	500 + 1 fuel cell
White	40	500 + 1 fuel cell

HC6 Pins – Hard Concrete (>C25) and Steel

Product Variant	Sizes (mm)	Pack Qty
Orange	15, 17, 22, 27, 32	500 + 1 fuel cell

Pins to Suit Pulsa 800E



C6 Pins – Standard Concrete (C25)

Product Variant	Sizes (mm)	Pack Qty
Black	20	500 + 1 fuel cell
Black	25	500 + 1 fuel cell
Black	30	500 + 1 fuel cell
Black	35	500 + 1 fuel cell
White	40	500 + 1 fuel cell

HC6 Pins – Hard Concrete (>C25) and Steel

Product Variant	Sizes (mm)	Pack Qty
Orange	15	500 + 1 fuel cell
Orange	17	500 + 1 fuel cell
Orange	22	500 + 1 fuel cell
Orange	27	500 + 1 fuel cell
Orange	32	500 + 1 fuel cell

More Spit Pulsa and Paslode accessories available.

WE KNOW A THING OR TWO ABOUT QUALITY



With temperature immune gas, 13,000 shots per charge lithium battery and best-in-class power to weight ratio, the IM360Ci system has been tailored specifically for the professional user.

 **Paslode**[®]

Power Tools

Our Brands



BOSCH

Invented for life



HITACHI



Products

Page No.

Cordless	33-35
Other Cordless Tools	36-39
Drilling	40-41
Metalworking & Grinders	42-43
Woodworking & Saws	44-46
Dust Management	47



Combination Drill

Combi drills have 3 functions:

The ability to drill holes into wood and metal, the ability to drive screws, the ability to drill holes into concrete and masonry via hammer function.

Entry/mid or top end there is a drill to suit every trade and budget.



Makita



Bosch



Dewalt



Hitachi

Rotary Hammer/Cordless SDS

A 2-mode SDS+ hammer drill will have rotary hammer and rotary only. You'll be able to drill into wood or metal (using rotary only) whereas by selecting the rotary hammer mode you'll be able to drill into masonry due to the hammer-action provided. 3-mode SDS+ hammer drill give you the same as a 2-mode, but with the addition of chiselling function.



Makita



Bosch



Dewalt



Hitachi

A FULL RANGE OF 18V POWER TOOLS AND GARDEN MACHINERY

SEE OUR FULL 18V RANGE AT WWW.MAKITAUK.COM

(36V) Twin 18V
Rotary Hammer
DHR263
DHR264



18V Rotary
Hammer
DHR242
DHR243



(36V) Twin 18V
Chainsaw
DUC353



(36V) Twin 18V
230mm Grinder
DGA900



(36V) Twin 18V
Plunge Cut Saw
DSP600



(36V) Twin 18V
Brush Cutter
DUR365U



18V Recip Saw
DJR187



18V Impact
Driver
DTD170



(36V) Twin 18V
Hedge Trimmer
DUH551



POWERFUL - QUIET RUNNING - LIGHTER WEIGHT - LONGER RUN TIMES



22
minute
charge



36
minute
charge



45
minute
charge



55
minute
charge

18V
LITHIUM-ION

18V + 18V → **36V**

Charge your 18V batteries in under one hour

Makita[®]

See our full range of products: www.makitauk.com

Drill Driver

This machine is more preferable when you do not require hammer action on your drill. Combi drills are more popular and in certain cases more cost effective.

All 18v machines come with torque settings.

When choosing a drill driver, take note of the capacity of holes it will allow you to drill and also the top torque setting as this will affect the sort of materials you can effectively drill screws into.



Makita



Bosch



DeWalt



Hitachi

Impact Drivers

An impact driver will be fitted with a hex chuck (or similar). This is a quick-release style mechanism that differs from the chucks found on combi and drill drivers. A hex chuck take hex screwdriver bits as an impact driver is essentially designed to drive screws into tough work pieces. However, with the correct bit fitted, you can also undertake some drilling applications. Impact drivers are all about hi-torque, coupled with high levels of impact. A typical impact driver will output higher levels of torque than even the top-of-the-range combi drill.

These are most popular in 10.8v and 18v.



Makita



Bosch



DeWalt



Hitachi

Other Cordless Tools

Jigsaws

A versatile hand-held electric saw that's perfect for a range of different jobs, including cutting shapes in wood and other sheet materials. A jigsaw features a reciprocating saw blade (one that goes backwards and forwards), providing a cutting motion similar to a handsaw.



Makita



Bosch



Dewalt



Hitachi

Mitre Saws

Mitre saws are known for precision and accuracy when it comes to cutting through long pieces of wood and other materials. Looking a bit like a circular saw on a swiveling base (or table) there are many features and styles to become familiar with.



Makita



Bosch



Dewalt

Circular Saws

A circular saw is the perfect power tool for cutting straight, clean and true. Use one on heavy timber, sheet materials or man-made boards like MDF and you'll see how quickly and easily you can make cuts that are perhaps messy or cumbersome with other saws.



Makita



Bosch



Dewalt



Hitachi

Other Cordless Tools

Reciprocating Saws

Reciprocating saws make demolition easier and more fun. You can struggle and rip it out with a variety of crowbars and hacksaws or you can use a reciprocating saw and just cut it free. It's the ultimate demolition tool. Windows, walls, plumbing, doors and more.



Makita



Bosch



Dewalt



Hitachi

Grinder



Makita



Bosch



Dewalt



Hitachi

Autofeed Drywall Gun



Makita



Bosch



Dewalt



Hitachi

Other Cordless Tools

Multi Tool



Makita



Bosch



Dewalt



Hitachi

Planer

A planer, planes the surface of the wood, and can cut the wood to a desired thickness.



Makita



Bosch



Dewalt



Hitachi

Impact Wrench



Makita



Bosch



Dewalt



Hitachi

Other Cordless Tools

Radios

FM/DAB radios available, most have bluetooth/IPOD/Phone/MP3 connectivity.



Makita



Bosch



DeWalt



Hitachi

Kits

From twin packs to 6 piece kits all the manufacturers have a variety to choose from, depending what tools you need for your trade is dependent on which kit you require. All come with batteries and chargers, and are either available in hard cases or bags (this depends on the size of kit you require). If you want to make your own kit up then we can accommodate that too with our range of naked tools.



Makita



Bosch



DeWalt



Hitachi

Drilling

Angle Drill

A right angle drill is designed to access spaces that conventional drill can't reach, those tight areas behind beams or joists that you simply can't get to otherwise. Most right angle drills have 3-speed motors. That offers plenty of torque when you need it and also allows for slow drilling when necessary.



Makita



Bosch



Dewalt



Hitachi

Percussion Drill

Percussion or impact drills have a specially designed clutch that allows it to not only spin the drill bit, but also to punch it in and out. The actual distance the bit travels in and out and the force of its blow are both very small but the hammering action is very rapid, thousands of BPM – Blows per Minute or IPM – Impacts per minute. These machines use standard smooth shank drill bits and as such they have either a Keyless or Keyed Chuck. The higher the wattage the more powerful the machine.



Makita



Bosch



Dewalt



Hitachi

Rotary Drill

These tools have no hammer action and are for drilling only, these are particularly good for the metal working industry due to the low/high speeds.



Makita



Bosch



Dewalt



Hitachi

SDS Drill/SDS Rotary Hammers

SDS Drills also operate in either 2 or 3 modes; machines with 2 modes offer Rotary Action (Impact Stop) or Hammer Action, whilst 3 mode machines offer both these plus a Rotation Stop function which switches off the Rotary Action and leaves just the Hammer Action – allowing the drill to be used as a breaker or demolition hammer with a suitable chisel bit. SDS Max machines are used in heavier-duty and larger applications and operate in 1 of 2 Modes only – Rotary Hammer or Rotation Stop.

SDS Rotary Hammers have such force that the usual masonry bits are not suitable. Their smooth shanks would be pounded loose from the tool's chuck in a few seconds. These machines require special SDS bits which can lock into the rotary hammer and continue to spin while smashing away. Also due to the nature of the work they do it means that SDS drills require a clutch which cuts in when the drill bit jams – thus stopping the violent wrenching motion that a drill without a clutch would cause when stopped suddenly from full speed.



Makita



Bosch



Dewalt



Hitachi

SDS Max/Demolition Hammer

Suitable for heavier-duty applications and do not operate in a rotary only mode. These use the SDS-Max bits. These bits have an 18mm shank with three open grooves and locking segments rather than balls, these are designed for use in SDS hammers over 5kg.

Demolition Hammers – For demolition work and heavy-duty use and do not operate in rotary only mode. These may more commonly be known as breakers.



Makita



Bosch



Dewalt



Hitachi

Diamond Core

Diamond core drill bits (sometimes called diamond hole saws) are used to drill holes in brick, concrete, block, and stone and similar material. They are ideal for cutting holes through walls for plumbing pipework.



Makita



Bosch



Dewalt



Hitachi

Metalworking & Grinders

Angle Grinder

Angle grinders are where the motor drives a geared head at a right-angle on which is mounted an abrasive disc or a thinner cut-off disc, either of which can be replaced when worn. Angle grinders typically have an adjustable guard and a sidehandle for two-handed operation. Certain angle grinders, depending on their speed range, can be used as sanders, employing a sanding disc with a backing pad or disc. The backing system is typically made of hard plastic, phenolic resin, or medium-hard rubber depending on the amount of flexibility desired. Larger wattage grinders do not come with a plug.



Makita



Bosch



Dewalt



Hitachi

Die Grinder

A die grinder, also known as a rotary tool, is a handheld power tool used for grinding, sanding, honing, polishing, or machining material (typically metal, but also plastic or wood). They are usually pneumatically driven, although electric and flexible shaft drive also exist.



Makita



Dewalt

Shear

For use in the metalwork industry normally to cut mild steel, stainless and aluminium. There are 2 sizes of shear 1.6mm or 3.2mm max cut in mild steel.



Makita



Bosch



Hitachi

Metalworking & Grinders

Nibbler

This tool is mainly used in the roofing industry and as it states “nibbles” out the steel leaving half moon shapes. As with the shear 1.6 and 3.2 are the main sizes.



Makita



Bosch



Hitachi

Cut Off Saw

There are 2 types, the first being a 355mm abrasive wheel machine, and the second a cold cut tct blade type. The cold cut machine is ideal where you need to minimise any sparks.



Makita



Bosch



Dewalt



Hitachi

Woodworking & Saws

Table Saw

Table, bench and site saws will allow you to perform crosscut, rip, mitre, and bevel cuts safely and with ease. A big advantage of using this type of saw over a mitre or circular saw for these cuts is that saw is stationary, allowing you to easily see the cut as you make it, keeping you safe into the bargain, especially important when performing big cuts in big work pieces.



Makita



Bosch



Dewalt

Reciprocating Saw

Reciprocating saws make demolition easier and more fun. You can struggle and rip it out with a variety of crowbars and hacksaws or you can use a reciprocating saw and just cut it free. It's the ultimate demolition tool. Windows, walls, plumbing, doors and more.



Makita



Bosch



Dewalt



Hitachi

Mitre Saw

Mitre saws are known for precision and accuracy when it comes to cutting through long pieces of wood and other materials. Looking a bit like a circular saw on a swivelling base (or table) there are many features and styles to become familiar with. There are different versions such as slide and compound mitre saws.



Makita



Bosch



Dewalt



Hitachi

Woodworking & Saws

Circular Saws

A circular saw is the perfect power tool for cutting straight, clean and true. Use one on heavy timber, sheet materials or man-made boards like MDF and you'll see how quickly and easily you can make cuts that are perhaps messy or cumbersome with other saws.



Makita



Bosch



Dewalt



Hitachi

Jigsaw

A jigsaw is a versatile handheld electric saw that's perfect for a range of different jobs, including cutting shapes in wood and other sheet materials. A jigsaw features a reciprocating saw blade (one that goes backwards and forwards), providing a cutting motion similar to a handsaw.



Makita



Bosch



Dewalt



Hitachi

Plunge Saw

A plunge saw is an essential power tool for joiners, carpenters, kitchen fitters, anyone who works with laminates, insulation or needs to make lots of cuts in small work pieces.



Makita



Bosch



Dewalt

Woodworking & Saws

Router

A router is a tool used to rout out an area in the face of a relatively hard workpiece, typically of wood or plastic. The main application of routers is in woodworking, especially cabinetry. The router is most commonly used as a plunging tool and also inverted in a router table.



Makita



Bosch



Dewalt



Hitachi

Planer

A planer, planes the surface of the wood, and can cut the wood to a desired thickness. The blades are standard 82mm wide and can come as tct or hss.



Makita



Bosch



Dewalt



Hitachi

Trimmer

A smaller version of the router, sometimes also known as a laminate trimmer, used mainly by kitchen fitters.



Makita



Bosch



Dewalt



Hitachi

Sander

There are different types of sander, orbital, belt, 1/2 and 1/3rd sheet. Choosing your sander depends on the size of surface and finish you require.



Makita



Bosch



Dewalt



Hitachi

Dust Management

Dust management is at the forefront of every site in relation to Health and safety. Dust is generated by many processes around construction sites and workshops. These processes include drilling, cutting, sanding, grinding, chasing and breaking. The HSE reported that there were around 39,000 individuals suffering breathing and lung problems in the UK. M Class dust extractors are the minimal legal requirement. There are 3 classifications L Class M Class and H Class.



Makita



Bosch



Dewalt

Power Tool Accessories

Our Brands



BOSCH

Invented for life

heller

get a bit more



Products

Page No.

Chucks and Adaptors	49
Drill Bits	50-51
SDS Chisels	51
Cavity Wall Drilling Bits	51
Tile and Glass Drill Bits	52
Wood Bits	52-53
Other Bits	53-54
HSS Twist Drill Bits	55
Holesaws	56
Blades	57
Diamond Core Cutters	58
Screw Driver Bits	58
Router Cutters	59
Abrasives	59-61
Multi Tool Accessories	62-63



Chucks and Adaptors

Toothed rim drill chuck with key 1/2" - 20 UNF



Quick action keyless chuck 1/2" - 20 UNF



SDS Plus Adaptor



SDS Plus Bit Holder



Chuck Key



Drill Bits

SDS Max Hammer Bits

SDS-MAX drill bits suitable for use in masonry and concrete.



Size (mm)	Working Length (mm)	Total Length (mm)
20, 22, 24, 25	200	320
12, 14, 15, 16, 18	200	340
28, 30, 32, 35, 37, 38, 40	250	370
20, 22, 24, 25, 26	400	520
12, 14, 15, 16, 18	400	540
28, 30, 32, 35, 37, 38, 40, 45, 50, 52	450	570
28, 35	550	670
12	550	690
16, 20, 22, 25, 28, 32, 37, 40	800	920
16, 18, 20, 22, 25, 28, 32, 35, 40	1200	1320

SDS Plus Hammer Bits

SDS-Plus drill bits suitable for use in masonry and concrete, including concrete with rebar. Appropriate for all rotary hammers with SDSplus holder.



Size Ø (mm)	Working Length (mm)	Total Length (mm)
5, 5.5, 6, 7, 8, 10	50	110
5, 5.5, 6, 6.5, 7, 8, 10, 11, 12, 14, 15, 16	100	160
5, 6, 6.5, 8, 10, 11, 12, 14, 15, 16	150	210
18, 20, 22, 24, 25, 28, 30	200	250
5, 6, 6.5, 8, 10, 11, 12, 14, 15, 16	200	260
6, 6.5, 8, 10, 11, 12, 14, 15, 16	250	310
10, 12, 14, 16, 18, 20, 22, 24, 25, 28, 30, 32	400	450
10, 12, 14, 16	550	600
10, 12, 14, 16	950	1000

Rebar Cutter Reinforcement Drill Bit



Size Ø (mm)	Working Length (mm)	Total Length (mm)
12, 14, 16, 18, 20, 25, 28, 30	190	230

Drill Bits

Masonry Drill Bit

Drill bits for use in brick, block, stone and light concrete.



Size Ø (mm)	Working Length (mm)	Total Length (mm)
3	36	60
4	40	70
5	50	85
6, 7	60	101
8	90	110
6, 7, 8, 9, 10, 11, 12, 13, 14, 15, 16	90	150
12, 14, 16, 18, 20	350	400
12	350	600
10	360	400
16, 20	550	600

SDS Chisels

SDS-MAX Chisels

- Cold Chisel
- Scaling Chisel
- Grooving Chisel
- Channel Chisel
- Chasing Brick Gouge
- Clay Sapde
- Digger Steel
- Mortar Chisel
- Curved Wide Chisel
- Bush Hammer Shank
- Angled Tile Chisel



SDS Plus Chisels

- Cold Chisel
- Scaling Chisel
- Grooving Chisel
- Tile Chisel
- Channel Chisel
- Wood Chisel
- Mortar Chisel



Cavity Wall Drilling Bits

SDS-MAX

Specifically designed for cavity wall, insulation technicians.



Size Ø (mm)	Working Length (mm)	Total Length (mm)
22, 26	130	265

Tile and Glass Drill Bits

Tile and Glass Drill Bits



Size Ø (mm)	Working Length (mm)	Total Length (mm)
3, 4, 5, 6	-	65
8	-	70
10, 12	-	80

Wood Bits

Standard 3 Point Wood Bits



Size Ø (mm)	Working Length (mm)	Total Length (mm)
3	30	60
4	43	75
5	50	85
6	58	95
7	70	110
8	73	115
9	80	125
10	85	135
13	96	151
14	120	170
12	100	155
15	100	160
16	130	180
18, 20	140	200
6, 8, 10, 12, 14, 16	150	315
18, 20	150	335

Wood Bits

Auger Wood Bits



Size Ø (mm)	Working Length (mm)	Total Length (mm)
6, 8, 10, 12, 14, 16, 18, 20, 22, 25	165	235
13, 15	180	250
8, 10, 12, 14, 16, 18, 20, 22, 24, 26, 28, 30	330	400
13, 15	380	450

Flat Wood Bits

Suitable for soft and hard wood, light building materials and plasterboard. Precision-ground tip, from toughened steel.



Size Ø (mm)	Working Length (mm)	Total Length (mm)
6, 8, 10, 12, 14, 15, 16, 18, 20, 22, 24, 25	125	150
26, 28, 30, 32, 34, 35, 36, 38, 40	130	160

Other Bits

Forstner Bit



Size Ø (mm)	Working Length (mm)	Total Length (mm)
10, 15, 20, 25, 26, 30	8	90
32, 35, 40, 50	10	90

Other Bits

Countersink Bits



Size Ø (mm)	Working Length (mm)	Total Length (mm)
50	13	¼" Hex
34	10.4	¼" C Form
35	12.4	¼" C Form
40	16.5	¼" C Form
41	20.5	¼" C Form
40	10	Cylindrical 6
40	12	Cylindrical 6
43	16	Cylindrical 6
45	20	Cylindrical 6
45	6.3	Cylindrical 5
50	8.3	Cylindrical 6
50	10.4	Cylindrical 6
56	12.4	Cylindrical 8
60	16.5	Cylindrical 10
63	20.5	Cylindrical 10
67	25	Cylindrical 10

Cone Drill Bits



Flute	Shank	Application
Straight	6 3 Flat	3-14
Straight	6 3 Flat	4-20
Straight	6 3 Flat	16-30.5
Straight	6 3 Flat	24-40

Step Drill Bits



Flute	Shank	Application
Straight	¼" Hex	4-20
Straight	6 3 Flat	4-32
Spiral	¼" Hex	4-12
Spiral	6 3 Flat	4-32

DIN388 RN

Size Ø (mm)	Working Length (mm)	Total Length (mm)	Cobalt	Ground	Rolled	Blacksmith with Reduced Shank
1	12	1	•	•	•	-
1.5	18	2	•	•	•	-
2	24	3	•	•	•	-
2.5	30	4	•	•	•	-
3	33	5	•	•	•	-
3.2	36	6	•	•	•	-
3.3	36	7	•	•	•	-
3.5	39	8	•	•	•	-
4	43	9	•	•	•	-
4.2	43	10	•	•	•	-
4.5	47	11	•	•	•	-
4.8	52	12	•	•	•	-
5	52	13	•	•	•	-
5.5	57	14	•	•	•	-
6	57	15	•	•	•	-
6.5	63	16	•	•	•	-
7	69	17	•	•	•	-
7.5	69	18	•	•	•	-
8	75	19	•	•	•	-
8.5	75	20	•	•	•	-
9	81	17	•	•	•	-
9.5	81	18	•	•	•	-
10	87	19	•	•	•	•
10.5	87	20	•	•	•	•
11	94	21	•	•	•	•
11.5	94	22	•	•	•	•
12	101	23	•	•	•	•
12.5	101	24	•	•	•	•
13	101	25	•	•	•	•
13.5	108	26	-	-	-	•
14	108	27	-	-	-	•
14.5	114	28	-	-	-	•
15	114	29	-	-	-	•
15.5	120	30	-	-	-	•
16	120	31	-	-	-	•
16.5	125	32	-	-	-	•
17	125	33	-	-	-	•
17.5	130	34	-	-	-	•
18	130	35	-	-	-	•
18.5	135	36	-	-	-	•
19	135	37	-	-	-	•
19.5	140	38	-	-	-	•
20	140	39	-	-	-	•
22	150	40	-	-	-	•
25	170	41	-	-	-	•

Holesaws

HSS Bi-Metal Holesaws

Dual pitch holesaw. Will cut a wide range of materials. Gives a smooth cut with minimal tendency to bite or snag



Size Ø (mm)	Working Length (mm)	Total Length (mm)
14, 16, 17, 19, 20, 21, 22, 24, 25, 27, 29, 30	32	½" - 20
32, 33, 35, 37, 38, 40, 41, 43, 44, 46, 48, 50, 51, 52, 54, 57, 59, 60, 64, 65, 67, 68, 70, 73, 76, 79, 83, 86, 89, 92, 95, 98, 102, 105, 108, 111, 114, 121, 127, 140, 152	32	5/8" - 18

Arbors /Drive Adaptor with HSS Pilot Bit



Size Ø (mm)	Working Length (mm)	Total Length (mm)
14 - 30	Triangular	½" - 20
14 - 30	Hex. 11	½" - 20
32 - 152	Hex. 11	5/8" - 18
14 - 30	SDS-Plus	½" - 20
32 - 152	SDS-Plus	5/8" - 18

HSS Pilot Bit



Size Ø (mm)	Working Length (mm)	Total Length (mm)
6.35	110	Triangular

Blades

Jigsaw Blades

Blades Available for the following applications:

- Special for Laminate
- Clean for Wood
- Speed for Wood
- Basic for Metal
- Flexible for Metal



All blades are supplied in packs of 5

Reciprocating Saw Blades

Blades Available for the following applications:

- Heavy for Metal
- Progressor for Metal
- Flexible for Metal
- Flexible for Wood & Metal



All blades are supplied in packs of 5

Circular Saw Blades



Application	Size Ø (mm)	Bore (mm)
Wood	160	20
Wood	190	20, 30
Wood	216	30
Wood	230	30
Wood	254	30
Wood	305	30
Wood	350	30
Wood	600	30
Mild Steel	305	25.4
Aluminium	216	30
Aluminium	250	30
Aluminium	260	30

Diamond Blades



Application	Size Ø (mm)	Bore (mm)
General Purpose	115	22.2
General Purpose	230	22.2
General Purpose	300	20
Asphalt & Abrasive Materials	230	22
Asphalt & Abrasive Materials	300	20
Turbo Fast Cutting	300	20
Concrete	300	20
Hard Ceramics	300	25.4

Diamond Core Cutters

Diamond Core Cutter

Diamond core cutters are available to cut a range of materials including: concrete, reinforced concrete, sandstone, bricks, granite, marble, limestone, slate and other dense and non-abrasive materials.



Length (mm)	Size Ø (mm)
400	12, 22, 32, 48, 65, 78, 117, 122, 152, 162

Screw Driver Bits

PH Phillips Bits

Description

PH1
PH2
PH3



PZ Pozidrive Bits

Description

PZ1
PZ2
PZ3



TX Torx Bits

Description

TX 20
TX 25
TX 30
TX 40



Bit Holder



Nut Driver



Router Cutters

Abrasives

Router Cutters



Description

- Straight Double Flute
- Double Guide Trimmer 90
- Straight
- Profile Guide
- Profile Guide 90
- Bearing Guide Edge
- Bearing Guide Edge Trimmer
- Guttering
- Grooving
- Rebate
- Biscuit Jointer
- Profile Guide with Top Bearing
- Straight Long Reach Double Flute
- Straight Single Flute
- Hinge Recessors Double Flute
- Helical Acrylic Double Flute
- Universal Countersink
- Chamfered Trimmers with Bearing
- Ovolo / Rounding Over
- Rounding Over with Bearing
- Staff / Corder Bead with Bearing
- Barley Twist
- Radius / Guttering
- Staff / Bull Nose
- Plunge and Trim
- Rebate with Bearing
- V-Grooving and Engraving
- Stairhousing Dovetails
- Roman Ogee with Bearing
- Hinge Sinkers

Sanding Belts



Size (mm)	Grits
6 x 533	40, 60, 80, 100, 120, 150, 240
9 x 533	40, 60, 80, 100, 120, 150, 240
13 x 533	40, 60, 80, 100, 120, 150, 240
30 x 533	40, 60, 80, 100, 120, 150, 180, 240
76 x 457	40, 60, 80, 100, 120, 150, 240
76 x 533	40, 60, 80, 100, 120, 150, 240
76 x 610	40, 60, 80, 100, 120, 150, 240
100 x 560	40, 60, 80, 100, 120, 150, 240
100 x 610	40, 60, 80, 100, 120, 150, 240
100 x 620	40, 60, 80, 100, 120, 150, 240

Abrasives

Sanding Sheets



1/2 Sheet Sanders

Size (mm)	Grits
115 x 229	40, 60, 80, 100, 120, 150, 180, 240
115 x 280	40, 60, 80, 100, 120, 150, 180, 240

1/3 Sheet Sanders

Size (mm)	Grits
93 x 185	40, 60, 80, 100, 120, 150, 180, 240
93 x 230	40, 60, 80, 100, 120, 150, 180, 240

Palm Sanders

Size (mm)	Grits
80 x 133	40, 60, 80, 100, 150, 180, 240
114 x 102	40, 60, 80, 100, 120, 150, 180, 240, 320
114 x 140	40, 60, 80, 100, 120, 150, 180, 240

Velcro Backed Abrasive Discs 6"

Size (mm)	Grits
150	40, 60, 80, 100, 120, 240, 320, 360, 400, 500
180	40, 60, 80, 100, 120, 240, 320, 360, 400, 500

Velcro Backed Abrasive Discs 5"

Size (mm)	Grits
125	40, 60, 80, 100, 120, 240, 320, 360, 400

Velcro Backed Delta Sheets

Size (mm)	Grits
94	40, 60, 80, 100, 120, 150, 180, 240, 320

Cut-off Wheels for Metal



Product Variant	Disc Size
A30S	100, 115, 125, 180, 230
A30R	100, 115, 125, 180, 230
A30T	100, 115, 125, 180, 230

Cut-off Wheels for Stone



Product Variant	Disc Size
C30T	100, 115, 125, 180, 230

Cutting Discs for Aluminium



Product Variant	Disc Size
C36R	115, 180, 230

Slitting Discs for Stainless Steel



Product Variant	Disc Size
WA60T	115, 125
A60T	100, 115, 125, 180, 230

Grinding Discs for Metal



Product Variant	Disc Size
A24R	100, 115, 125, 180, 230
A36P	100, 115, 125, 180, 230

Grinding Discs for Aluminium



Product Variant	Disc Size
A36N	100, 115, 125, 180, 230

Cutting Disc - Electric and Petrol Cutters



Product Variant	Disc Size
A30R - metal	300, 355, 406
C24RBF - stone	300, 355, 406

Multi Tool Accessories

Segment Knife



Serrated Groove Cutter



Plunge Cut Blade



Tiling Set



Scraper



Diamond-Riff Blade



Multi Tool Accessories

Segment Saw Blade



Flooring Set



Precision Plunge Cut Blade



Universal Groove Cutter



Sealants & Adhesives

Our Brands



Products

Page No.

Professional Sealants	66-69
Sealant Guns	70
Expanding Foams & Accessories	71
Fillers	72
Glazing Cleaners & Wipes	72-73
Grab Adhesives	73-76
Contact Adhesives	76
Wood Adhesives	76-77
Super Glue & Activators	77
Glue Gun & Sticks	78
Smart Tack Adhesives, Guns & Accessories	78
Tile Adhesives	79
PVA	80
Primers	81





BUILDING TRUST



Everbuild Building Products - A Sika Company is the UK's largest manufacturer of sealants, adhesives, fillers and building chemicals.



Professional Sealants

Forever White

A superior anti-bacterial silicone sealant that is permanently waterproof and flexible. Ideal for use in bathrooms.

Colours:

White, Clear

Sizes:

C3



General Purpose Silicone

Mid modulus silicone sealant that adheres to most smooth and non-porous materials. Contains an anti-fungal compound to prevent mould growth in areas of high humidity.

Colours:

Black, Brown, Grey, Clear, White

Size:

C3



115 GP Building Mastic

Traditional oil based pointing mastic that provides an effective weatherproof seal.

Colours:

Brown, Grey, Stone, White

Sizes:

C3



125 One Hour Caulk

Fast drying flexible decorators filler and sealant that remains permanently flexible.

Colours:

Brown, Magnolia, White

Sizes:

C3, C4



Silicone 825

Low modulus, neutral curing Silicone sealant based on a filled alkoxy curing system. Used for expansion joints to masonry.

Colours:

Anthracite, Beige, Black, Brown, Brick Red, Buff, Dark Grey, Limestone White, Magnolia, Mid Grey, Portland Stone, White

Size:

380ml



200 Contractors Silicone

Contract grade, quick curing, mould resistant.

Colours:

Black, Brown, Clear, White

Size:

295ml



Professional Sealants

225 Industrial & Glazing Silicone

Mid modulus acetoxy cure silicone sealant that adheres to most smooth and non-porous substrates. Typically used for single glazing, draught-proofing and general industrial use.

Colours:

Black, Brown, Brushed Steel, Clear, White

Size:

C3



335 Construction Silicone

Low modulus, cost-effective PVCu sealant.

Colours:

Black, Brown, Bronze, Grey, Toffee, Translucent, White

Size:

C3



450+ Builders Silicone

Premium quality low modulus non-corrosive neutral cure silicone.

Colours:

Buff, Black, Brown, Clear, Grey, White, Translucent*

Sizes:

C3, *600ml



500 Bath & Sanitary Silicone

Premium quality high modulus acetoxy cure silicone sealant that contains a high level of powerful anti-fungal compound. Typically used in areas of high humidity.

Colours:

Clear, Grey, Ivory, Sandstone, White

Size:

C3



700T LMN Silicone

Fast, neutral curing, low modulus sealant specially formulated for the PVCu and roofline industry.

Colours:

Black, Brown, Bronze, Caramel, Mahogany, Clear*, White*

Sizes:

C3, *600ml



Fire Sealant 300

Intumescent and acoustic sealant.

Colours:

White, Grey, Black

Sizes:

380ml, 600ml



Professional Sealants

AC95 Acoustic Intumescent Sealant

Premium quality acoustic sealant & adhesive.

Colour:

White

Size:

900ml



AC50 Acoustic Sealant & Adhesive

Contract grade acoustic sealant & adhesive.

Colour:

White

Sizes:

C4, 900ml



Fire Mate Sealant

Intumescent acrylic sealant.

Colours:

Brown, Grey, White

Sizes:

C3, 600ml



Lead Mate Sealant

Alternative too mortaring lead flashing and sheet into masonry, providing a fully waterproof joint that will not crack or shrink.

Colour:

Grey

Size:

C3



Silicone Eater

Revolutionary chemical that digests and breaks up all types of silicone sealant.

Size:

150ml



Roof & Gutter Sealant

Premium quality butyl based sealant and adhesive.

Colour:

Black

Size:

C3



Professional Sealants

Contractors 100DC

Acrylic sealant & filler.

Colour:

White

Size:

280ml



Contractors 200MP

Acetoxy silicone.

Colours:

White, Clear, Black, Brown

Size:

280ml



Contractors 700NS

Neutral silicone.

Colours:

White, Clear, Caramel, Teak

Size:

280ml



Silirub 2

Premium quality low modulus non-corrosive neutral silicone, ISO 11600 F&G 25 LM.

Colours:

Brilliant White, Clear, Teak, Brown, Black, Caramel, Mahogany, Toffee, Anthracite Grey, White, Grey, Alu-Grey, Portland, Beige, Stone, Concrete Grey, Oak, Light Brown, Dark Brown, Terracotta, Basalt Grey, Buff, Bronze

Size:

300ml, 310ml, 600ml



Sealant Guns

Professional Sealant Gun

We offer a range of sturdy sealant guns.

Sizes:
C3, C4



Sealant Gun

We offer a range of sturdy sealant guns.



Foil Pack Applicator Gun

We offer a range of Foil Applicator Guns



Expanding Foams & Accessories

Fix & Fill Expanding Foam

Expanding foam filler can be used for insulating, filling gaps and dampening sound. We offer both hand held and gun grade foam fillers and accessories.



Hand Foam B1

Firefoam B1 Handheld is a quick-setting fire rated, one part polyurethane foam. It expands on application to yield up to 50 times the can contents and meets the extremely stringent requirements of the test criteria BS476 Part 20; Class B1.



Hand Foam B2

Firefoam B2 Handheld is a quick setting fire rated, one part polyurethane foam in a ready to use hand held canister.



Expanding Foams & Accessories

Gun Foam B1

Firefoam B1 Gun Grade is a quick-setting fire rated, one part polyurethane foam. It expands on application to yield up to 50 times the can contents and meets the extremely stringent requirements of the text criteria DIN 4102 Part 1 for Construction Materials, Class B1 and BS 476 Part 20.



Gun Foam B2

Firefoam B2 Gungrade is a quick setting fire rated, one part polyurethane foam designed for application by any standard foam applicator gun.



Dual Purpose Foam Cleaner

Dual Purpose Foam Cleaner is used to remove wet/uncured foam. Attaches to Gun Foam Applicator for purging through; also includes spray nozzle for use without applicator to remove wet foam from outside of the gun and from most building substrates.



Foam Eater

Everbuild Foam Eater is a revolutionary paste designed for the safe removal of cured PU foam and adhesives from most substrates.



P45 Medium Duty Metal Gun

P45 Foam Gun gives the user more control to apply the foam precisely in hard to reach places, saving unnecessary wastage. For both professional and DIY use.



P65 Heavy Duty Metal Gun

P65 Foam Gun gives the user more control to apply the foam precisely in hard to reach places, saving unnecessary wastage. For professional use.



Fillers

One Strike

A revolutionary filler formulated using lightweight polymer bubbles that fills most holes and cracks, even deep holes, in just one quick application with no need for secondary filling to level off as One Strike will not shrink, sag or crack. One Strike Filler finishes smooth, requiring little or no sanding and can be ready to paint in approximately 30 minutes.

Sizes:

250ml, 500ml, 1ltr, 2.5ltr, 5ltr, 10ltr



2 Part Wood Filler – High Performance

2 Part High Performance Wood Filler is a fast drying, exterior and interior wood filler. The 2 Part Wood Filler is easy to mix and apply and is completely weatherproof. Once mixed, the filler sets hard to a shatterproof finish in approximately 30 mins and may be drilled, carved or planed once dry.

Colours:

Beech, Mahogany, Light Oak, Pine, Redwood, Light Stainable, Medium Stainable, Teak, White

Sizes:

500g, 6kg, 1.4kg

Multi Purpose Wood Filler & Stopper

Multi-Purpose Wood Filler fills nail holes, cracks, gaps and minor imperfections in wood. It is easy to sand and can be stained, varnished and painted and is solvent free.

Colours:

Light, Medium

Sizes:

100ml, 250ml, 310ml

Glazing Cleaners & Wipes

Glass Cleaner

Glass Cleaner is a powerful glass cleaning agent containing a high level of detergents and solvents for rapid drying to a smear and static free finish. May also be used on tiling, VDUs, TV screens, chrome etc.

Sizes:

1ltr, 5ltr, 25ltr



PVCu Cream Cleaner

PVCu Cream Cleaner is a solvent-free formulation designed to remove ingrained dirt, stains and pollution from PVCu window frames without scratching. Buffs to a deep sheen.

Size:

1ltr



Glazing Cleaners & Wipes

Silicone Spray

All Purpose Silicone Spray is a dry silicone lubricant and mould release agent for the easing of friction between two surfaces. Ideal for use in mould making/release industries, to ease installation of rubber and EPDM gaskets to window and door frames and has 100's of uses around the home, garage, workshop and industry.

Size:
400ml



PVCu Solvent Cleaner

PVCu Solvent Cleaner is a solvent based product formulated to remove ingrained dirt from PVCu and most plastics. Also suitable to restore an "as new" look to old windows and plastic garden furniture.

Size:
1ltr



Wonder Wipes

Multi-Use Wonder Wipes have become the first choice wipe of the nations builders and tradesmen. Specially formulated to clean hands, tools and surfaces from wet and semi-cured paint, sealant, adhesive, bitumen, expanding foam, oil, grease and even silicone.

Size:
100 wipes



Grab Adhesives

We have a large selection of adhesives to suit your needs from top brands available in different colours and sizes.

Pinkgrip

Revolutionary initial 'Direct Bond' eliminates the need for double stick methods.

Colour:
Pink
Size:
350ml



Pinkgrip SF

Solvent free Pinkgrip.

Colours:
Pink, White
Size:
C4



Grab Adhesives

Griptite

Extra-tough, high grab construction adhesive.

Colours:

Buff, Green

Sizes:

310ml, 350ml



Gun A Nail Standard

Solvent free, high strength multi-purpose building adhesive. Suitable for use where at least one of the substrates to be bonded is porous.

Colour:

Beige

Size:

C3



Stixall

Ultimate combined building and sealant with the power to both bond and seal virtually everything to anything in virtually any conditions, even under water or in the rain.

Colours:

Black, Brown, Grey, White

Size:

300ml



Gun A Nail Extra

High strength adhesive ideal for bonding two non-porous materials together.

Colour:

Beige

Size:

C3, C4



Instant Nails

High strength solvent free gap filling multi use adhesive that provides a quick grab and replaces mechanical fixings in many home improvement applications. Dries white and may be overpainted if required.

Colour:

White

Size:

C3



Contractors 500SB

Solvent based adhesive.

Colour:

Beige

Size:

280ml



Contractors 600SF

Solvent free adhesive.

Colour:

White

Size:

280ml



Contractors 800MS

Hybrid polymer adhesive & sealant.

Colour:

White

Size:

280ml



Contractors 900MS

Hybrid polymer adhesive & sealant.

Colour:

Clear

Size:

280ml



FixALL Flexi

Multi purpose SMX sealant/adhesive.

Colours:

White, Black, Grey, Brown

Size:

290ml



FixALL Crystal

Crystal clear SMX sealant/adhesive.

Colour:

Crystal Clear

Size:

290ml



FixALL High Tack

High strength SMX sealant/adhesive.

Colours:

White, Black, Grey, Brown

Size:

290ml



Grab Adhesives

FixALL Turbo

Superfast SMX sealant/adhesive.

Colour:

White

Size:

290ml



FixALL Extreme

Extreme tack SMX sealant/adhesive.

Colour:

White

Size:

290ml



Contact Adhesives

Stick 2 All Purpose Contact Adhesive

Premium grade rubber based contact adhesive suitable for use with a wide variety of material for both professional and DIY use.

Colour:

Beige

Sizes:

125ml, 250ml, 750ml, 5ltr



Wood Adhesives

D4 Wood Adhesive

Solvent free industrial grade wood adhesive based upon hybrid resin technology. Can be used internally or externally. Dries clear and sets in 10 minutes.

Colour:

White



502 All Purpose Weatherproof Wood Adhesive

High quality, resin based wood adhesive for all wood bonding. Can be used internally or externally. Ideal for general woodworking and joinery use.

Sizes:

75ml, 125ml, 250ml, 500ml, 1ltr, 5ltr, 25ltr



Wood Adhesives

5 Minute Polyurethane Wood Adhesive Gel

Thixotropic, transparent, gap filling gel which sets hard in 5 minutes. Ideal for equipment manufacture and production line applications where rapid handling is required.

Colour:
Translucent
Size:
310ml



30 Minute Polyurethane Wood Adhesive Gel

Thixotropic, transparent, gap filling gel which sets hard in 30 minutes.

Colour:
Translucent
Size:
310ml



Super Glue & Activators

Industrial Superglue GP

Ideal for use on PVCu, plastic, glass and metals.

Colour:
Clear
Size:
20g



Superglue De-Bonder

Removes excess cured and wet superglue from most surfaces.

Colour:
Clear
Size:
20ml



Threadlock GP Blue

For use on nuts, bolts, screws and threads. Can be used on oil contaminated parts.

Colour:
Blue
Size:
10g



Mitre Fast Bonding Kit

2-part instant adhesive and aerosol activator. Suitable for use on plastics and timber.

Colour:
Clear
Size:
Standard, Large



Glue Gun & Sticks

Glue Gun Professional

High temperature 193°C, low temperature 120°C, 80 watts.



Glue Sticks

High temperature glue sticks for use with glue gun 7/16".

Size:
11mm diameter



Smart Tack Adhesives, Guns & Accessories

Smart Tack Handy

Standard aerosol for smaller jobs. Offers all benefits with lower pressure application. Coverage: 500ml aerosol will cover 4-5m² of laminate when applied to both surfaces.

Colour:

Blue

Size:

500ml



Smart Tack Bulk Tank

For large scale use, delivers adhesive via a flexible hose to the gun. Bulk Tank will cover 120m² of laminate when applied to both surfaces.

Colours:

Blue, Clear

Size:

17kg



Smart Tack Bulk Tank Gun

For use with Smart Tack bulk tank and hose.



Smart Tack Bulk Tank Hose

For use with Smart Tack bulk tank and gun. Hose length: 3.66 metres



701 Super Plus Non Slip

Non Slip Tile Adhesive is an acrylic based formula for extra slip resistance and grab.

Colour:
Off White

Sizes:
1ltr, 2.5ltr, 5ltr, 10ltr



702 Aqua Plus Water Resistant

Premium grade adhesive that can be used in areas subject to prolonged/permanent wet conditions and in areas of high humidity and condensation.

Colour:
Off White

Sizes:
1ltr, 2.5ltr, 5ltr, 10ltr



703 Fix & Grout

Premium grade adhesive formulated to be used as both an adhesive and grout. The product contains a fungicide to prevent mould growth and dries to a brilliant white finish.

Colour:
White

Sizes:
500ml, 1ltr, 2.5ltr, 5ltr, 10ltr



715 Tile on Timber

Ready mixed tile adhesive and grout that retains flexibility. For use when laying tiles on prepared timber floors. Allows for sub floor movement without cracking adhesive or grout. Ideal for most interior areas, highly flexible polymerised formula. Can also be used on concrete and stone floors in interior applications

Colour:
Grey

Size:
10ltr



705 Rapid Set Tile Mortar

Fast-setting thick or thin bed adhesive for bonding ceramic tiles to floors and most walls where same day fixing and grouting is required. Can be used internally and externally and bonds to most building substrates such as concrete, cement screeds and render.

Colour:
Grey

Sizes:
10kg, 20kg



711 Rapid Set Flexiplus

Quick setting floor and wall tile mortar with added latex powder for improved flexibility. Can be used on prepared wooden floors, interior and exterior use where same day fixing and grouting is required.

Colour:
Grey

Sizes:
10kg, 20kg



PVA

501 PVA Bond

Multi-purpose bonding agent, primer, sealer, cement and plaster admixture that adheres to most common building and DIY materials. Ideal for priming unsound surfaces prior to plastering or painting, as an adhesive on wood, cork, textiles and most applications where at least one surface is porous, for general dust sealing on flaking paintwork/walls etc and as a cement and plaster admixture.



Sizes:

500ml, 1ltr, 2.5ltr, 5ltr, 25ltr

Pro Point Gun Kit

Mortar Pointing Gun Kit comes complete with nozzles for both mortar and tile grout as well as a mixing paddle. Designed to apply mortar deep into joints for maximum protection and strength. Comes complete with two plastic nozzles, a metal ended nozzle and a mixing paddle packed in a high impact printed box.



Pro 45p

PU cavity filling, ultrafast, water resistance D4.

Colour:

Brown

Sizes:

750kg, 5kg



Pro 40p

PU cavity filling, water resistance D4.

Colour:

Brown

Sizes:

750kg, 5kg



Purocol

PU high strength, solvent free, water resistance D4.

Colour:

Transparent

Sizes:

310ml



Primers

Primer 100

For silicone and PU sealants on porous surfaces.

Colour:

Clear

Size:

500ml



Primer 150

For MS and silicone sealants on porous surfaces.

Colour:

Clear

Size:

500ml



White Spirit

White Spirit is a solvent designed for thinning paints and varnishes, cleaning brushes and general household degreasing and cleaning. Conforms to BS245.

Colour:

Clear

Sizes:

750ml, 2ltr, 4ltr



Lubricating Oil

A penetrating oil and water-displacing spray.

Colour:

Clear

Size:

400ml



Tapes

Our Brands



Products

Page No.

Masking Tape	83
Gaffa Tape	83
Hazard Warning Tape	83
Easi-Peel Tape	83
High Tack PVC Tape	83
Double Sided High/Low Tack Tape	83
Self Adhesive Drywall Tape	83
Mega All Purpose	83
Buff Packaging Tape	84
PTFE Tape	84
Double Sided Tape	84
Barrier/Zebra Tape	84
Foil Tape	84
Electrical Insulation Tape	84



Tapes

Masking Tape

General purpose tape for various light duty applications.

Colour:
Off White

Width:
25, 38, 50, 75, 100mm

Length:
50m



Gaffa Tape

General purpose tape for jointing product to product.

Colours:
Black, Silver, White

Width:
50, 75, 100mm

Length:
50m

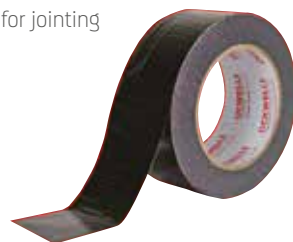

Hazard Warning Tape

Warning tape to highlight hazards in and around construction sites.

Colours:
Red & White,
Black & Yellow

Width:
50mm

Length:
33m

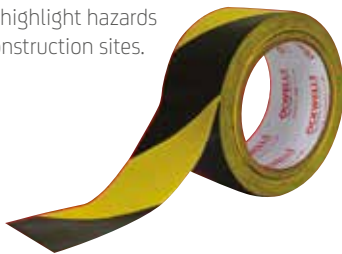

Easi-Peel Tape

General purpose tape for jointing product to product.

Colour:
White

Width:
50, 75, 100mm

Length:
33m

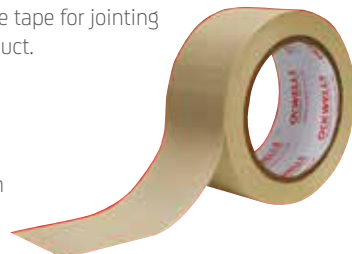

High Tack PVC Tape

Generally used in the construction industry for polythene jointing and shuttering tape.

Colour:
Black

Width:
50, 75, 100mm

Length:
33m



Double Sided High/Low Tack Tape

A double-sided tape that is useful in a variety of applications.

Colour:
Blue

Width:
50mm

Length:
50m

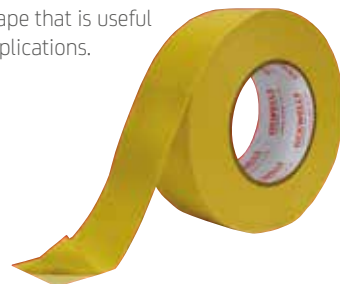

Self Adhesive Drywall Tape

Flexible self-adhesive tape to cover plasterboard joints, also known as scrim tape.

Colour:
Off White

Width:
48mm

Length:
90m



Mega All Purpose

Top quality cloth with aggressive natural rubber adhesive. Tough, durable and waterproof, for thousands of applications on site, in the home and industry.

Colours:
Black, Red, Silver, White

Width:
50mm

Length:
50m



Tapes

Buff Packaging Tape

Low noise, quality packaging tape, ideal for all packing applications.

Width:
48mm
Length:
66m



PTFE Tape

WRAS & EN751-3 Approved. Complies with BS7786 1995 Grade L. Also suitable for potable water.

Width:
12mm
Length:
12m



Double Sided Tape

High tack multi-purpose double sided tape, bonds to most smooth surfaces and is ideal for securing many items to smooth surfaces, vertically and horizontally.



Barrier/Zebra Tape

Super strength non adhesive polythene barrier tape in tape dispensing box.

Colours:
Red & White, Black & Yellow
Width:
70mm
Length:
100m



Foil Tape

A high tensile strength aluminium foil backing, combined with a cold weather solvent acrylic adhesive, protected by an easy-release silicone release paper.

Colours:
Silver
Width:
50, 75, 100mm
Thickness:
30, 40 Microns



Electrical Insulation Tape

Flame retardant, easy to unwind PVC electrical insulation tape for providing insulation to most electrical wires.

Colours:
All Colours
Width:
19, 50mm
Length:
33m





SOUDATHERM ROOF

The **Fastest** Roof Bonding System



The Soudatherm Roof range offers great suitability with most common roofing applications, including creating a vapour barrier, roof refurbishment & insulation.

Soudatherm Roof 170

- Solvent Free Liquid PU Adhesive.
- Traditional Technology.
- Covers approx. 33m²

Soudatherm Roof 250

- Expanding Foam PU Adhesive specifically formulated for roofing applications.
- Suitable for vertical applications.
- Covers approx. 60m²

Proud sponsors of:



Soudatherm Roof 330

- Ideal for bonding PIR/PUR/XPS/EPS
- Low maintenance: can be stored under pressure for 2 weeks.
- Covers approx. 120m²

Safety & Clothing

Products	Page No.
Workwear	87
Hi-Visibility Clothing	88
Knee Pads	88
Eyewear	88
Footwear	89
Respiratory	89
Hearing Protection	90
Hand Protection	91-93
First Aid	93



T-Shirts

Classic T-Shirt Black.

Colour:

Black

Sizes:

S – XXL



Trousers

Cargo Trousers.

Colour:

Black

Sizes:

28" – 52" Waist



Fleeces

Full zip micro fleece.

Colour:

Black

Sizes:

S – XXL



Disposable Workwear

Tyvek classic xpert coverall.

Colour:

White

Sizes:

S – XXXL



Sweatshirts

Sweatshirt.

Colour:

Black

Sizes:

XS – XXL



Waterproof Clothing

2 Piece rainsuit.

Colour:

Yellow

Sizes:

S – XXL



Hi-Visibility Clothing

Waistcoats

Waistcoat.

Colour:

Yellow

Sizes:

S - XXXL



Hi-vis T-Shirts

Hi-vis T-Shirt.

Colour:

Yellow

Sizes:

S - XXL



Jackets

Motorway style jacket.
Bomber jacket.

Colour:

Yellow

Sizes:

S - XXXL



Hi-vis Trousers

Hi-vis trousers.

Colour:

Yellow

Sizes:

S - XXL



Knee Pads

Knee Pads

Knee pads.

Colour:

Black



Eyewear

Safety Specs

Javelin wraparound
style clear lens.

Colour:

Clear



Footwear

Chukka Boots

Colour:

Black

Sizes:

3 – 13



Work Boots

Flint hiker boot composite.

Colour:

Honey

Sizes:

6 – 12



Work Shoes

Tuf safety shoe.

Colour:

Black

Sizes:

3 – 13



Safety Trainers

Tuf safety work trainer.

Colour:

Black

Sizes:

3 – 12



Respiratory

All our face masks and respirators comply with EN149:2001 FFP1, FFP2 or FFP3.

Respair E FFP3V Disposable Mask

Size:

5/Box



Respirators

3M valved reusable half face mask.

Size:

Single



JSP Force 8



Hearing Protection

A range of hearing protection offers various levels of protection up to SNR35.

Ear Muffs

Tufmuff standard earmuff.

Colour:
Black/Red



Dispensers & Refills

Classic earplug refill.

Colour:
Yellow

Size:
500 Pairs



Disposable Ear Plugs

Classic earplug 250 pairs.

Colour:
Yellow

Size:
250/box



One Touch Dispenser

Colours:
Blue/Yellow



Corded/Branded Ear Plugs

Ear cap banded earplug.

Colour:
Blue/Yellow

Size:
Each



Anti-Vibration Gloves

Velvet shock anti-vibration glove.

Colour:

Yellow

Sizes:

9 – 11



Builders Grip Gloves

Builders grip glove.

Colour:

Green

Sizes:

8 – 10



Cotton Gloves

Cotton chrome gloves.

Colour:

White



Disposable Gloves

Utah powderfree disposable nitrile.

Colour:

Blue

Sizes:

S – XL



General Handling Gloves

Latex coated glove.

Colour:

Orange

Sizes:

8 – 10



Leather Gloves

Cow grain hide lined driver glove.

Colour:

Yellow



Hand Protection

Nitrile Coated Gloves

Nitrile palm coated nylon glove.

Colour:

Black

Sizes:

8 – 10



PU Coated Gloves

Colour:

Black

Sizes:

8 – 10



Rigger Gloves

Standard Canadian rigger glove. General handling, non hazardous environments, janitorial and gardening.

Colour:

Multi



Thermal Gloves

Thermal lined glove.

Colour:

Black

Size:

Pair



Single/Double Dip PVC Gloves

Red PVC fully coated K/ Wrist glove.

Colour:

Red

Sizes:

7 – 10



Thermal Grip Gloves

Winter Hi-vis builders grip glove.

Colour:

Blue/Yellow

Sizes:

8 – 10



Hand Protection

Protective Sleeves

70-114 (KS14) 14" kevlar sleeve.

Colour:

Yellow

Size:

Each



Cut Resistant Glove

100% seamless knitted Kevlar liner. Latex coated palm and fingers.

Colour:

Blue/Yellow



First Aid

First Aid Kits

Various sizes are available.

Product Variations:

112 Aura HSE 10 Person First Aid Kit

113 Aura HSE 20 Person First Aid Kit

114 Aura HSE 50 Person First Aid Kit



Hand Tools

Our Brands



Products

Page No.

Levels	95
Marking Out	95
Measuring	96
Screwdriver/Keys	96-97
Hammers	97
Chisels and Bolsters	98
Pliers & Snips	98
Saws	99
Handy Tools	99
Wrenches	99
Knives	100
Blades	101
Stapling	101
Taping Knives	102
Hawk	102
Trowels	102-103
Floats	103
Mixing Paddle	103
Sanders	104
Buckets	104
Detectors	105
Shovels	105
Painting	105



Levels

Spirit Levels

We supply mid-range and professional spirit levels in various sizes. The most popular sizes are 60cm, 120cm and 180cm.



Fatmax Xtreme Torpedo Level

FatMax Torpedo level is 10 inches in length with 3 vials and has a V groove machined in the magnetic base, which allows it to fit firmly on pipe work, ideal for scaffolders, plus it is also perfect for installing machinery, air conditioning ducting or shelving.



Marking Out

Rapid Chalk Line & Chalk & Level

Rapid chalk line 30 metre (100 feet), 113g chalk powder (red) and mini level set. With its geared action, this chalk line winds up to three times faster than a traditional reel. The water resistant housing has a non-slip rubber grip for user comfort and ease of use, and a large mouth for easy powder refilling.



Combi Square

This combination square has a cast iron stock and is therefore more robust for heavy-duty use. It is fitted with a level and scribe. Has graduations on both sides of blade in mm, 8th's and 16th's inches.



Plumb Bob

A centre and cross hole fixing system permit a line to be attached through the centre line of the bob helping to provide an accurate centre reading.



Measuring

Pocket Tape Measures

Available in 2m, 3m, 5m, 8m and 10m from brands like Stanley, Ox, Irwin and Faithful.



Long Tapes

Also known as a Surveyors Tape, we can supply tapes ranging from 10m to 100m



Fatmax Tape Measure

The heavy-duty Stanley Tools FatMax Tape Measure has a huge standout from their 32mm wide blade. The Mylar coating makes the blade 10 times more resistant to abrasion.



Surform® Block Plane

For use on all types of wood, aluminium, copper, plastics and laminates. The metal body gives strength and durability and a thumb screw provides a quick blade release.



It is supplied fitted with a 140mm (5.1/2in) fine cut blade.

Available in:
5m and 8m

Screwdriver/Keys

Ratchet Screwdriver

Multibit screwdriver ratchet with 10 bits.



Screwdriver Set

Screwdriver set cushion grip flat/phil.

Various pack sizes available



Screwdriver/Keys

Hexagon Keys

The ball design allows you to use it in two positions providing the strength of a standard key with the speed and angle of a ball key. Storage caddy allows quick tool selection and handle storage.

**Available in:**

Various sizes and packs.

Screwdrivers

We have a variety of Screwdriver kits to suit your needs from suppliers such as Wera, Stanley, Faithful and Irwin. The four main tip choices are: Slotted, Pozi, Phillips or Torx.

There are other more specialised screwdrivers such as Nutspinners, VDE, plus a wide range of security bits available.



Screw Extractor Set

Screw Extractor Kit easily removes even the most damaged and hard to remove screws and bolts.



Hammers

Nail Punch Set

Nail punch dynagrip – set of 3.



Claw Hammers

A hammer with one side of the head split and curved, used for extracting nails. Available with wooden, steel, fibreglass or graphite shaft. Our most popular sizes are 14oz, 16oz and 20oz.



Sledge Hammers

General purpose heavy hammer for builders and contractors.

Virtually unbreakable fibreglass shaft with a soft-grip non-slip handle and overstrike protection.

Available in:

7lb, 10lb and 14lb.



Club Hammers

General purpose Club Hammer with striking faces specially hardened and heat treated to withstand the most high impact heavy applications.



Chisels and Bolsters

Chisel Set

Bevel edge chisel
dynagrip+ strike
cap 5 pc+ acc.



Brick Bolster

Suited to cutting bricks during building work. This chisel has a suitably hardened cutting edge, but should not be used on concrete containing reinforcing bars.



Cold Chisel

Made from high quality grade steel which is hardened and ground to maximise safety and to ensure longer lasting cutting edges.

For cutting brick, concrete and paving slabs.



Wood Chisels

This bevel edged wood chisel has a ground finished, hardened and tempered alloy steel blade, with a one piece, solid impact resistant blue polypropylene plastic handle. The blade is lacquered for rust prevention.



Pliers & Snips

Pliers Set

Carpenter Stanley pincer set.



Multitool

Pocket multitool 12 piece multi tool.



Aviation Snips

Metal shear aviation snip – straight.



Saws

Hand Saw

Universal panel saw



Fine Finish Saw

Hand saw 22 11TPI.

Size:
22"/550mm



Insulation Saw

The WT-toothing is specially designed for cutting insulation material with the blade being re-sharpenable with any regular knife sharpener

**Suitable for:**

Mineral wool or Glass wool.
EPS: Expanded Polystyrene.
XPS: Extruded polystyrene.
Stone wool or Rock wool.

Hacksaw

Lightweight frame with 150kg blade tension, a comfort grip handle and an integrated storage for replacement blades.

Various brands and sizes available as well as replacement blades



Tenon Saw

Hardpoint tenon saw with soft-grip handle for user comfort. The ideal choice for fine carpentry and can be used with a mitre box. Available in 10", 12" and 14"



Jabsaw

Hardened and tempered blade for durability and long life.

Moulded handle combining high impact plastic and soft touch inserts for improved comfort and control. Large smooth end pad to facilitate pushing and twisting blade through plasterboard. Sharp point for piercing board. Aggressive triple bevel teeth for a faster cleaner cut.



Blade Length:
150mm (6in). Teeth 7 tpi

Handy Tools

Utility Bar

Designed for such tasks as opening boxes, crates and manhole covers. It is ideal for removing nails and prying lightweight doors and windows, as well as a multitude of other light levering applications



Wrenches

Adjustable Wrench

The drop forged construction and the moulded soft-grip handle combine strength with comfortable use. The adjustable jaw enables each wrench to be used on a number of different sized nuts or bolts.

Various brands and sizes available.



Knives

Fatmax Retractable Folding Knife

Suitable for all job applications from carpet fitting, model making and craft design to electrical installation.

Retractable blade and folding knife.

Blades can be stored in the handle for safe keeping.



Trimming Knife – Retractable

The blade extension can be controlled by the blade shifter, and 5 blade positions allows a wider usage for a variety of cutting applications.

The interlock nose firmly secures the blade into knife. For safety, the blade can be fully retracted into the body. Supplied with 3 blades, stored in the handle for safety and convenience.



Titan Fixed Blade Knife

Fixed blade knife titan trimming.



Trimming Knife – Snap Off

The removable blade snapping tool on the knives provides a means of safely and quickly detaching used blade segments, and three spare strips of blades are located within the integral blade storage system. Replacement blades available.

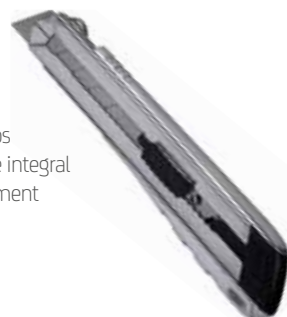

199 Trimming Knife Card

Fixed blade knife 199E trim grey.



Safety Knife

The Stanley Folding Pocket Safety Knife is an auto-retract knife with instant change blade. It folds neatly in half to fit in the pocket and to reduce the risk of injury.



Blades

50 Pack Carbide Blades

Knife blade carbide knives & blades blades.

Various pack sizes available.



Heavy Duty Knife Blades

Heavy-duty, general purpose blades, which fit all standard knives.

Various pack sizes available.



1992 Knife Blade

Knife blade 1992B heavy-duty.

Various pack sizes available.



1996 Knife Blade

Knife blade 1996B hooked.

Various pack sizes available.



Snap Off Knife Blades

Available in 9mm and 18mm.

Various pack sizes available.



Window Scraper



Stapling

Heavy Duty Staple/Nail Gun

Staple tacker & acc's heavy-duty/nail gun.



Heavy Duty Staples

We have various staple and pack sizes available which fit multiple brands of staple guns.



Heavy Duty Tacker

Staple reload window allows you to reload staples when needed. Ideal for upholstery, boards, foam, fabrics and gardening applications.



Taping Knives

Taping Knife

Drywall taping knives are used for spreading jointing compound and when applying paper or fibreglass drywall tape, to cover joints in plasterboard.



Jointing Knife

The blade has been tapered from handle to tip which provides flexibility.



Hawk

Plaster Hawk

Useful tray from which to apply plaster or cement quickly to a wall by using a trowel.



Metal Hawk

Professional grade aluminium plasterers hawk with cast aluminium strengthening back plate, foam rubber callous protector and soft-grip handle for user comfort. 12" x 12"



Trowels

Bucket Trowel

A bucket trowel has a tapered blade that has been cut square and is designed for removing mortar from the sides and bottom of buckets.



Pre-worn Plasterer's Finishing Trowel

Stainless steel finishing trowels that have been pre-worn and pre-shaped.

Available in:
11" and 13".



Pointing Trowel

A small bladed trowel designed for use in forming brick joints and repairing or replacing weathered joints. These trowels are also a popular choice for shaping and retouching damaged mortar in many situations.



Internal Corner Trowel

Lightweight internal corner trowel for finishing internal angles.



Trowels

Brick Trowel

A larger more flexible blade make these trowels a very popular choice, ideal for bricklaying and perfect for block laying application where more mortar is required.



External Corner Trowel

Lightweight and perfectly balanced outside corner trowel with a blade set at an 80° angle that flexes during use to 90° to form a clean square corner.



Gauging Trowel

Gauging trowels are used primarily for measuring, mixing and applying small quantities of cement



Floats

Plasterer's Float

This sturdy float is a lightweight one piece polyurethane moulding. The pattern face is non-absorbent and is used for applying plaster, cement and other building materials.



Available in:
11" and 14".

Mixing Paddle

Mixing Paddle

Mixing paddles have a robust construction for heavy-duty work. They are great for mixing plaster, render, paint, adhesives, mortar, paste and screed. Available in different sizes and quality.



Sanders

Hand Sander

A lightweight hand sander which is extensively used in the dry walling industry for sanding the joints between plasterboards after they have been filled.



Extension Pole

Top quality aluminium extension poles that can be adjusted to the required length. Fitted with a metal threaded roller attachment and an easy push-fit adaptor system that will accept all 180mm (7 inch), 230mm (9 inch) and 300mm (12 inch) roller frames on the UK market.

Sizes:
40cm - 60cm.



Pole Sander

Swivel action pole sander head extensively used in the dry walling industry for sanding the joints between plasterboard on ceilings and high walls after they have been filled. Ideal for sanding and smoothing difficult to reach areas such as corners, without the use of a step ladder.



Buckets

Builder Bucket

Standard-duty black builders bucket manufactured using recycled materials.

Available in:
40L and 65L



Flexi Bucket

Lightweight, heavy-duty polyethylene, flexible tub features super-strong comfortable handles and is ideal for solids and fluids.

Available in:
15L, 28L, 42L and 60L.



Detectors

Stud Detector

A handy instrument that uses a safe, non-contact method to detect AC voltage in outlets, lighting fixtures, circuit breakers, wires and cables and can be used to find circuit breaks in a wire.



Shovels

Shovels

We have many types of shovels including: insulated, square, tapers, socket, draining and micro shovels.



Painting

Paint Roller Kit

Suitable for use on both smooth and rough surfaces.



Paint Brushes

The Faithfull Superflow Paint Brushes have synthetic bristles which are made from 100% polyester tapered filaments and which guarantee excellent performance with no bristle loss.

Available in:
1/2", 3/4", 1", 1 1/2", 2", 3" 4".



Paint Kettle

Plastic Paint Kettle is suitable for use with all types of paint.



Site Equipment

Our Brands



Products

Page No.

Podium	107
Combi Ladders	107
Step Ladders	108
Extension Ladder	110
Telescopic Ladder	110
Work Platform	110
Heavy Duty Storage	111-117
Medium Duty Storage	118
Misc.	119
Site Protection	120-122
Dust Sheets	122
Electrical - Cable Reels	123
Electrical - Extension Leads	123



Podium

Sherpascopic Podium

Inexpensive, height-adjustable platform ladder with a large-area work platform 600 x 420 mm and 4-sided peripheral railing for maximum safety.

Height adjustment from rung to rung; thus different heights can be obtained with only one platform ladder.



Number of Rungs	Size (m)
4/6	1 – 1.5
7/9	1.75 – 2.25

Combi Ladders

Skymaster

Upper ladder with parking hooks and lift-off retainer. Can be used on steps/stairs.



Number of Rungs	Size (m)
3 x 6	1.9 – 4.1
3 x 7	2.2 – 5
3 x 8	2.4 – 5.8
3 x 9	2.7 – 6.7
3 x 10	3.6 – 9
3 x 12	3.6 – 8.6
3 x 14	4.1 – 9.7

GRP41521 Industrial Skymaster

3 section fibreglass ladder with aluminium side locking arm for “A” frame configurations. Comes with wide stabilising base with anti-slip feet, lockable ladder sections for transport or during use and anti-splay, nylon straps.



Number of Rungs	Size (m)
3 x 8	2.45 – 5.8

Step Ladders

GRP Platform Steps

Fibreglass.



Tread	Size (m)
1 x 3	0.82
1 x 4	1.05
1 x 5	1.33
1 x 6	1.6
1 x 7	1.87
1 x 8	2.38
1 x 10	2.76

Class 1 Stepladder



Tread	Size (m)
5	1.06
6	1.27
8	1.69
10	2.11
12	2.83

Class 1 Platform Steps

Patented 7-point connection between tread and stile with reinforcing support rod through the centre of the tread, for added strength and safety. Includes integral hanging points for paint and tools, for convenience while you work and non-slip, replaceable rubber feet provide firm footing.



Tread	Size (m)
3	0.61
4	0.83
5	1.04
6	1.26
7	1.48
8	1.7
10	2.13
12	2.56

Class 1 Triples

3-part extension ladders with D-shaped rungs. Large "D" shaped serrated rungs provide a comfortable horizontal surface during use and easy, precise rung-by-rung adjustment. Rung hooks and locking tabs secure the sections together during use and transport. Overall width of bottom section: 490 mm



Tread	Size (m)
3 x 8	2.4 – 5.2
3 x 10	3 – 6.9
3 x 12	3.54 – 8.3
3 x 14	4.1 – 10



armorgard
ticking every box.

the toughest storage in the industry

Armorgard is guaranteed to tick every box when it comes to protecting your tools and equipment.

- » Industry leading, innovative design solutions
- » Strong products for any environment
- » Expert, friendly team to assist with your requirements



armorgard
rubble truck™



armorgard
toolbox

Order now from SIG

Extension Ladder

Class 1 Doubles

2-part extension ladders with D-shaped rungs. Large “D” shaped serrated rungs provide a comfortable horizontal surface during use and easy, precise rung-by-rung adjustment. Rung hooks and locking tabs secure the sections together during use and transport. Overall width of bottom section: 420 mm



Tread	Size (m)
2 x 8	2.4 – 3.8
2 x 10	3 – 4.95
2 x 12	3.5 – 6
2 x 14	4.1 – 6.9
2 x 16	4.66 – 8
2 x 18	5.22 – 9.42

Telescopic Ladder

Telemaster

Allows multiple working heights, with rung by rung height adjustment. The treads lock automatically during extension, and are extra wide for comfortable use. Collapses to a small size, and so stores easily into car boot or cupboard.



Tread	Size (m)
3.3m	0.78 – 3.3
3.8m	0.84 – 3.8

Work Platform

Hop Ups

A convenient and safe way to reach low level heights, ideal for decorating or low level maintenance tasks. The Hop Up has a large platform 600mm x 300mm offers comfortable and safe working position with folding legs lock in place during use and fold neatly under the platform for storage. Includes plastic feet to provide firm placement during use.



Dimensions	Height (m)
300 x 600	0.47
600 x 600	0.47

Heavy Duty Storage

BundleRack

Effective means of transporting and storing large bundles of materials and other site equipment.



Size W x D x H (mm)

1005 x 1560 x 1010

Cuttingstation

Work station for cutting lengths of metal, such as conduit, cable tray and pipe. Integral health and safety features include fire-rated sound deadening foam to reduce noise pollution, and PVC screens to contain and protect from sparks.



Size W x D x H (mm)

1360 x 800 x 1820, 1200 x 800 x 850 (top),
1200 x 770 x 765 (bottom)

Chembank

The high security lockable vault for the safe storage of chemicals.

Purpose-built for the safe storage of chemical substances.



Product Variant Size W x D x H (mm)

Site Box	1275 x 665 x 660, 1185 600 x 575
Site Chest	1275 x 675 x 1270, 1185 x 605 x 1185

Drumbank

The enclosed store and spill pallet for the safe storage of oil drums. Designed for the safe storage and dispensing of oil drums.



Product Variant	Weight (kg)	External Dimensions W x D x H (mm)	Internal Dimensions W x D x H (mm)
Drumbank	177.5	1320 x 980 x 1400	1290 x 860 x 1100
Drumbank	231	1420 x 1390 x 1360	1390 x 1300 x 1100
Drumbank Pallet	20	1310 x 750 x 435	
Drumbank Pallet	31.5	1290 x 1380 x 280	

Chemcube Cabinet



External Dimensions W x D x H (mm)

1225 x 450 x 1050

Internal Dimensions W x D x H (mm)

1220 x 450 x 1050

Heavy Duty Storage

Drumstor

Built to order and customised to your exact specification, this is the ultimate heavy-duty storage solution for all your chemicals and flammables.



Weight (kg)	Size W x D x H (mm)
1200	3000 x 1650 x 2350
2050	5900 x 1650 x 2350
1800	3000 x 1500 x 3250
2200	5900 x 1500 x 3250
2850	8800 x 1500 x 3250
4500	8800 x 3000 x 3250

Flambank

The ultra-tough, lockable vault for storing hazardous chemicals and flammables.



Product Variant	Weight (kg)	External Dimensions W x D x H (mm)	Internal Dimensions W x D x H (mm)
Van Box	46	980 x 540 x 475	895 x 470 x 465
Site Box	64	765 x 675 x 670	680 x 605 x 575
Site Box	81.5	1275 x 665 x 660	1185 x 600 x 575
Site Chest	107	765 x 675 x 1270	680 x 605 x 1180
Site Chest	152.5	1275 x 675 x 1270	1185 x 605 x 1185
Site Chest	174	1585 x 675 x 1275	1500 x 605 x 1185
Site Chest	334	2370 x 985 x 1220	2350 x 895 x 1130

Fittingstor

Designed to secure all your costly M&E components and tools in one safe, easily portable location.



Weight (kg)	External Dimensions W x D x H (mm)	Internal Dimensions W x D x H (mm)
88.5	800 x 585 x 1450	790 x 540 x 1170
139	1200 x 580 x 1750	1185 x 510 x 1465
132.5	1010 x 580 x 1575	995 x 505 x 1295

Flamstor Cabinet

Similar to the Flamstor cabinet, but with the addition of specially designed flameproof vents to prevent build-up of fumes.



Weight (kg)	External Dimensions W x D x H (mm)	Internal Dimensions W x D x H (mm)
44.5	500 x 530 x 980	490 x 465 x 895
74	800 x 585 x 1250	790 x 540 x 1170
110.5	1205 x 580 x 1555	1185 x 510 x 1475

Flamstor Collapsible

This versatile walk-in store is purpose-designed for securing larger quantities of chemicals or flammable substances where access is restricted.



Weight (kg)	External Dimensions W x D x H (mm)	Internal Dimensions W x D x H (mm)
520	2160 x 2350 x 2200	2000 x 2000 x 2000
630	2160 x 3080 x 2200	2000 x 3000 x 2000
780	2160 x 4080 x 2200	2000 x 4000 x 2000

Flamstor

Perfect solution for storing larger quantities of chemicals or flammable substances.



Weight (kg)	Size W x D x H (mm)
300	1200 x 1200 x 2100
375	1200 x 1800 x 2100
500	2000 x 2000 x 2100
680	2000 x 3000 x 2100
900	2000 x 4000 x 2100
1150	2000 x 6000 x 2100

Gorlla Gas Cage

A modular bolt-together design using individual Galvanized panels, making it quick and easy to erect and dismantle.

Constructed using 25mm box sections and 3mm wire mesh.



Weight (kg)	Size W x D x H (mm)
40	1000 x 500 x 900
60	900 x 500 x 1800
68	1200 x 1200 x 1200
67	900 x 900 x 1800
87	1200 x 1200 x 1800
98	1800 x 900 x 1800
108	1800 x 1200 x 1800
135	1800 x 1800 x 1800
165	2400 x 1800 x 1800
188	2700 x 1800 x 1800
182	2400 x 2400 x 1800
226	2400 x 3600 x 1800
270	2400 x 4800 x 1800
314	2400 x 6000 x 1800
279	3600 x 3600 x 1800
205	3600 x 1800 x 1800

LoadAll



Product Variant	Weight (kg)	External Dimensions W x D x H (mm)	Internal Dimensions W x D x H (mm)
LA750	41	550x1350x1130	550x1350x300
LA1000	49	730x1250x1410	730x1250x495

Heavy Duty Storage

Piperack

Wheeled storage rack to manoeuvre materials while working on site.



Weight (kg)	External Dimensions W x D x H (mm)	Internal Dimensions W x D x H (mm)
83	1000 x 1500 x 1560	1000 x 1500 x 545
101	1000 x 1500 x 1560	1000 x 1500 x 545

Mobile TuffBench

A combination of Heavy-duty storage cabinet and multi-purpose work surface, this innovative workbench makes any job that bit easier, while ensuring that your tools and equipment remain safe from thieves and damage.



Weight (kg)	External Dimensions W x D x H (mm)	Internal Dimensions W x D x H (mm)
78	1120 x 705 x 920	990 x 630 x 640
97.5	1200 x 700 x 940	990 x 630 x 640

(w/wood top)

Pipestor

Portable secure storage trunk, gives you the peace of mind that your copper piping is safe 24/7.



Weight (kg)	External Dimensions W x D x H (mm)	Internal Dimensions W x D x H (mm)
133	575 x 3205 x 785	495 x 3160 x 495
256	575 x 6410 x 785	495 x 6350 x 495

Powerstation

Battery charging locker bank allows you to charge your equipment unattended, confident in the knowledge that it is safe from thieves. Specially designed for charging power tools, mobile phones and devices and other electrical devices.



Weight (kg)	External Dimensions W x D x H (mm)	Section Dimension W x D x H (mm)
26.5	300 x 450 x 1800	295 x 425 x 275

Safestor

Medium-duty cabinet that complies with all COSHH regulations. Purpose-built for the indoor safe storage of flammables and chemicals, including paint and other hazardous substances.



Product Variant	Weight (kg)	External Dimensions W x D x H (mm)	Section Dimension W x D x H (mm)
SafeStor	20.5	900 x 465 x 700	890 x 395 x 640
SafeStor	12.5	350 x 315 x 700	890 x 395 x 640
SafeStor	28	900 x 465 x 900	890 x 395 x 840
SafeStor	31	450 x 465 x 905	440 x 395 x 840
SafeStor	41	900 x 465 x 1200	890 x 395 x 1140
SafeStor	68	1200 x 465 x 1800	1190 x 395 x 1740
SafeStor	55	900 x 465 x 1800	890 x 395 x 1740
SafeStor Mobile	25.5	900 x 465 x 810	890 x 395 x 640
SafeStor Mobile	33	900 x 465 x 1010	890 x 395 x 840
SafeStor Stand	10	N/A	N/A
SafeStor Stand	5	N/A	N/A

Sitestation

A convenient place for performing routine on site tasks, while also providing secure storage for your valuable equipment.

Comes with Sitestation internal light and available with or without wheels



Weight (kg)	External Dimensions W x D x H (mm)
253.5	1355 x 835 x 2000

StrimmerSafe Vault

A secure storage range specially designed for housing strimmers and similar long handled tools.



Weight (kg)	External Dimensions W x D x H (mm)	Internal Dimensions W x D x H (mm)
140.5	1970 x 675 x 665	1880 x 605 x 580
68.5	1275 x 515 x 450	1190 x 445 x 445
63	1800 x 555 x 445	1710 x 480 x 440

StrimmerSafe Rack



Weight (kg)	Size W x D x H (mm)
93	2055 x 365 x 2085, N/A

Toolbin

Manufactured from galvanized steel, this lightweight vault is designed for storage of less valuable items and where high security is not a priority.



Weight (kg)	External Dimensions W x D x H (mm)	Internal Dimensions W x D x H (mm)
22.5	1190 x 585 x 850	1150 x 555 x 825

Heavy Duty Storage

Strongbank

Manufactured using 3 and 5mm steel, with vulnerable areas specially strengthened, this state-of-the-art strongbox delivers virtually indestructible performance to deter even the most determined thief.



Product Variant	Weight (kg)	External Dimensions W x D x H (mm)	Internal Dimensions W x D x H (mm)
Strongbank Van Box	59	1030 x 565 x 480	895 x 460 x 470
Strongbank Site Box	98	1310 x 690 x 665	1185 x 605 x 575
Strongbank Site Box	120	1300 x 690 x 970	1185 x 600 x 880
Strongbank Truck Box	138	2000 x 690 x 665	1885 x 605 x 580

Transbank

The cost-effective secure container for storing hazardous fuels and chemicals.



Weight (kg)	External Dimensions W x D x H (mm)	Internal Dimensions W x D x H (mm)
12.5	430 x 415 x 365	345 x 345 x 335
20	530 x 485 x 540	445 x 415 x 510
23.5	705 x 485 x 540	620 x 415 x 510
27.5	880 x 485 x 540	790 x 415 x 510
37.5	1195 x 485 x 540	1110 x 415 x 510

Transbank Chem

The safe vault for storage and transportation of smaller volumes of chemicals.



Weight (kg)	External Dimensions W x D x H (mm)	Internal Dimensions W x D x H (mm)
12.5	430 x 415 x 365	345 x 345 x 335
20	530 x 485 x 540	445 x 415 x 510
27.5	880 x 485 x 540	790 x 415 x 510

Tuffbank

Heavy duty steel plate construction and unique Armorgard anti-jemmy technology mean that it is virtually impregnable to all but the most sophisticated thief.



Product Variant	Weight (kg)	External Dimensions W x D x H (mm)	Internal Dimensions W x D x H (mm)
Van Box	45	980 x 540 x 475	895 x 470 x 465
Truck Box	58.5	1275 x 515 x 450	1190 x 445 x 445
Site Box	61	765 x 675 x 670	675 x 605 x 575
Site Box	86	1275 x 665 x 660	1185 x 600 x 575
Site Box	105.5	1270 x 675 x 975	1185 x 605 x 880
Site Chest	159	1275 x 675 x 1270	1185 x 605 x 1185
Site Chest	166	1585 x 675 x 1275	1500 x 605 x 1185
Truck Box	123	1970 x 675 x 665	1880 x 605 x 580

Tuffstor Cabinet

The ultra-tough cabinet that keeps your equipment organised and accessible.



Weight (kg)	External Dimensions W x D x H (mm)	Internal Dimensions W x D x H (mm)
44	500 x 530 x 980	490 x 465 x 895
74	800 x 585 x 1250	790 x 540 x 1170
112.5	1205 x 580 x 1555	1185 x 510 x 1475

Tuffcage

Constructed from galvanized heavy duty steel, this robust high security cage is suitable for storing gas cylinders as well as tools and equipment.



Weight (kg)	External Dimensions W x D x H (mm)	Internal Dimensions W x D x H (mm)
133	1300 x 1240 x 1800	1220 x 1090 x 1760

Tuffstor

High security walk-in store is the perfect solution for storing larger equipment or quantities of tools.



Weight (kg)	Size W x D x H (mm)
290	1200 x 1200 x 2100
365	1200 x 1800 x 2100
480	2000 x 2000 x 2100
660	2000 x 3000 x 2100
870	2000 x 4000 x 2100
1100	2000 x 6000 x 2100

Tuffstor Collapsible

Medium duty walk-in storage unit for fixed installation, ideal for storing larger equipment or quantities of tools where access is limited.



Weight (kg)	External Dimensions W x D x H (mm)	Internal Dimensions W x D x H (mm)
325	2140 x 2075 x 2100	2000 x 2000 x 2000
400	2140 x 3060 x 2100	2000 x 3000 x 2000
500	2140 x 4050 x 2100	2000 x 4000 x 2000

Medium Duty Storage

Barrobox

Robust, versatile and easy to operate, this ingeniously designed portable box solves the problem of on site tool theft.



Weight (kg)	Size W x D x H (mm)
80	740 x 1095 x 720, 600 x 795 x 605

GritKart

Specially designed for storing and transporting salt or grit for use on construction sites. Highly manoeuvrable and ultra-sturdy.



Weight (kg)	External Dimensions W x D x H (mm)	Internal Dimensions W x D x H (mm)
10.2	590 x 420 x 1080	510 x 385 x 500

SpillKart

Versatile cart for storing and transporting your spill control essentials. Complies with hse requirements.



Weight (kg)	External Dimensions W x D x H (mm)	Internal Dimensions W x D x H (mm)
15	590 x 420 x 1080	510 x 385 x 500

SafetyKart

A mobile incident response unit designed to carry all your vital emergency equipment.



Weight (kg)	External Dimensions W x D x H (mm)	Internal Dimensions W x D x H (mm)
38.5	680 x 420 x 1200	600 x 265 x 1015

Oxbox

Medium duty range of tool vaults designed for use where budget is a consideration.



Product Variant	Weight (kg)	External Dimensions W x D x H (mm)	Internal Dimensions W x D x H (mm)
Van Box	27	915 x 490 x 450	830 x 425 x 440
Truck Box	39	1215 x 490 x 450	1130 x 425 x 440
Site Box	58	1200 x 665 x 630	1115 x 595 x 545
Site Chest	104	1210 x 640 x 1175	1125 x 565 x 1090
Truck Box	58.5	1800 x 555 x 445	1710 x 480 x 440

Barricade

The expandable safety barrier. The barricade is a concertina barrier, designed to clearly mark out a working area, extendable up to 4 metres long and finished in powder coat to maximise durability.



Weight (kg)	External Dimensions W x D x H (mm)	Internal Dimensions W x D x H (mm)
25	450 x 300 x 950	4000 x 300 x 950

Tuffdor

Constructed from heavy-duty galvanized steel, tuffdor is a fast and easy way of securing rooms or buildings on a short term basis.



Weight (kg)	External Dimensions W x D x H (mm)	Internal Dimensions W x D x H (mm)
67.5	1150 x 185 x 2110	720 x 40 x 1865

TuffBench

Heavy-duty folding work platform is a versatile workbench designed for contractors on the move, and is perfect for use on construction sites.



Weight (kg)	External Dimensions W x D x H (mm)	Internal Dimensions W x D x H (mm)
27	1080 x 750 x 820	1080 x 750 x 130

Site Protection

Glass Protection Film

UV stable temporary protection for glazed windows and doors. Provides temporary protection from scratches, dust, paint and mortar spills.



Colour:

Blue

Size

600mm x 100m

Carpet Protection Film

Developed to protect carpets during any new build. Refurbishment and other maintenance projects.



Colours:

Clear/White

Sizes

600mm x 100m HD Std

900mm x 100m HD Std

1200mm x 100m HD Std

600mm x 100m FR TS63

800mm x 100m FR TS63

1200mm x 100m FR TS63

TwinShield Protection Board

General purpose protection board available in standard and flame retardant variants.



Colours:

Black/Translucent

Sizes

2mm – 2.4m x 1.2m Std Black

2mm – 2.4m x 1.2m Std Trans

2mm – 2.4m x 1.2m FR LPS1207

Hard Surface Protection Film

Developed to protect hard floor in areas under construction and refurbishment.

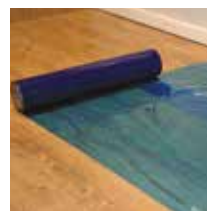

Colour:

Blue

Sizes

600mm x 100m Std

600mm x 100m FR TS63

ArmaShield HD Protection Board

Used as a heavy duty equivalent to Ockwells TwinShield for various applications.



Colours:

White/Black

Sizes

3mm – 2.4m x 1.2m FR (White)

4mm – 2.4m x 1.2m FR (Black)

CheckerTile

CheckerTile is manufactured from ultra-heavy duty hard wearing PVC Embossed with a checker plate pattern providing a high level of slip resistance. CheckerTile's lightness makes it easy to move around site and is also reusable, making it a very cost effective alternative to traditional plywood and other floor coverings. The interlocking jigsaw design allows the tiles to be flexible and easy to fit.

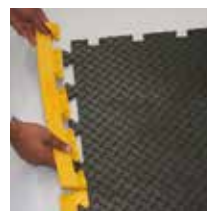

Colour:

Black

Size

14mm – 500mm x 500mm

TecDura Stickymat LD

Ockwells TecDura mats offer a seamless, non-slip covering that adheres to the substrate.

Colours:

White/Yellow



Size

1040mm x 50m

Stairtread Protectors

A rigid protective cover ideal for both commercial and domestic stair installations. This unique design provides a high degree of protective cover, excellent grip, impact and scuff resistance to either bull-nosed timber treads in domestic house building or square fronted concrete treads in commercial buildings.



Colour:

Yellow

Sizes

750mm x 210mm

1500mm x 210mm

Handrail Safety Posts

Generally used to form a temporary and reusable safety rail as staircases and balustrades are often only installed once the build is complete.

Colour:

Red

Variants:

Safety Post Standard

Safety Post Corner

Safety Post Stringer Fixing



Polythene Flame Retardant Sheeting

Manufactured from a fully accredited Flame Retardant Polythene certified to LPS 1207. Available in light, medium and heavy duty grades.

Colour:

White/Orange

Sizes

4m x 50m LD (White)

4m x 50m MD (White)

4m x 25m HD (Orange)



OckProps

Generally used in conjunction with polythene to construct temporary screening on site. High quality reusable fibreglass and aluminium props with push button telescopic adjustment used to construct temporary screening.

Colour:

Orange/Blue



Size

1.69m extending to 3.2m

Zip Door Kits

Can be adhered to standard and flame-retardant polythene to create sealable doorways. Zip strips can be used in pairs to form large access for trades and materials in to work areas.



Site Protection

Rubble Sacks

Generally used for the removal of site rubbish and rubble. Manufactured from heavy duty clear polythene to meet stringent site rules on waste. Holds a capacity of approximately 50kg.



Colour:

Clear

Size

50kg 100/pk

Pallet Wrap

General uses include the wrapping of bricks, blocks and other site materials. Also suitable as a wrapping protection for steel beams and columns to protect from contamination especially in the winter months.



Colour:

Clear

Size

400mm x 300m

Dust Sheets

Cotton Dust Sheets

Genuine cotton twill, protect from spills, splashes and dust. Strong hardwearing cotton resists wear from tools, stepladders and feet. Reversible, machine washable.



Colour:

Yellow

Size

12' x 9'

Stairway Cotton Dust Sheets

Top quality cotton twill sized to suit stairways.

Colour:

Yellow



Size

24' x 3'

Polythene Dust Sheets

Waterproof and rotproof one-piece general purpose polythene dust sheet. Ideal for covering furniture when decorating, plus many other usages.



Electrical - Cable Reels

110V Floor Stand Plastic Reel 16A 2 Outlet. Trip



Size
25m
50m

230V Floor Stand Plastic Reel 13A 2 gang. Trip



Size
25m
50m

Electrical - Extension Leads

110V 16A Plug & Coupler



Size
1.5mm²
2.5mm²

110V 32A Plug & Coupler



Size
4 mm²

A

Activators	77
Adaptors	49
Adhesives:	
Contact Adhesives.....	76
Grab Adhesives.....	73 – 76
Smart Tack Adhesives & Accessories.....	78
Tile Adhesives.....	79
Wood Adhesives.....	76 – 79
Anchors:	
Shield Anchors.....	23
Sleeve Anchors.....	23
Angle Drill	40
Angle Grinder	42
Aviation Snips	98

B

Blades	101
Block Plane	96
Bolsters	98
Buckets	104

C

Cable Reels	123
Chemical Storage	111 – 115
Chisels:	
Cold Chisel.....	98
Sets.....	98
Wood Chisel.....	98
Chucks:	
Chuck Key.....	49
Keyless Chucks.....	49
Toothed Rim Drill Chucks.....	49
Circular Saw:	
Corded.....	45
Cordless.....	36
Cleaning:	
Glass Cleaner.....	72
PVCU Cream Cleaner.....	72
PVCU Solvent Cleaner.....	73
Silicone Spray.....	73
Wonder Wipes.....	73
Coach Bolts	8
Collated Screws	
Classic.....	6
Coarse Thread.....	6
Fine Thread.....	6
Flooring.....	6
Solo.....	6
Wingtip Self Drill.....	6
Combi Square	95
Combination Drill	33
Concrete Screw	9

Cut-off Wheels:

Metal.....	60
Stone.....	60

Cut Off Saw.....43

Cutting Discs:

Aluminium.....	60
Electric and Petrol Cutters.....	61

D

Decking Screws	20
Diamond Core	41
Diamond Core Cutters	58
Die Grinder	42
Doors – Safety	119
Drill Bit Holders	49
Drill Bits:	
Cavity Wall Drill Bits.....	51
Cone Drill Bits.....	54
Countersink Bits.....	54
Forstner Bit.....	53
HSS Twist Drill Bits.....	55
Masonry Drill Bits.....	51
Rebar Cutter Reinforcement Bits.....	50
SDS Chisels.....	51
SDS Max Hammer Bits.....	50
SDS Plus Hammer Bits.....	50
Step Drill Bits.....	54
Tile and Glass Bits.....	52
Wood Bits.....	52 – 53

Drill Driver.....35

Drop-in-Anchors.....19

Drywall Autofeed.....37

Drywall Screws:

Coarse Thread.....	5
Collated Drywall Screws.....	5
Fine Thread.....	5
Self Drill.....	5
Wafer Head Self Drill.....	5

Dust Management.....47

Dust Sheets.....122

E

Electrical Cable Reels.....123

Expandable Safety Barrier.....119

Expanding Foam:

Fire Rated Frame Foam.....	12
Fix & Fill Expanding Foam.....	70
Gun Foam.....	71
Hand Foam.....	70

Expanding Foam Accessories

Extension Leads.....	123
Foam Cleaner.....	71
Foam Eater.....	71
Metal Gun.....	71

Fillers:	
Wood Filler	72

F

First Aid Kits	93
Float	103
Floor Protection:	
Carpet Protection Film	120
CheckerTile	120
Hard Surface Protection Film	120
Mats	120
Protection Board	120
Footwear:	
Chukka Boots	89
Safety Trainers	89
Work Boots	89
Work Shoes	89

G

Gas Storage	113
Glass Protection	120
Gloves:	
Anti-Vibration	91
Builders Grip	91
Cotton	91
Cut Resistant	93
Disposable	91
General Handling	91
Leather	91
Nitrile Coated	92
Protective Sleeves	93
PU Coated	92
Rigger	92
Single/Double Dip PVC	92
Thermal	92
Thermal Grip	92
Glues:	
Glue Gun	78
Glue Sticks	78
Gun Kits	80
PVA	80
Super Glue	77
Super Glue De-Bonder	77
Grinder	37
Grinding Discs:	
Aluminium	61
Metal	61

H

Hawks:	
Metal Hawk	102
Plaster Hawk	102
Heavy Duty Anchors:	
Shield Anchors	23
Sleeve Anchors	23

Hammer Fixings:	
Metal Nail Ins	15
Nylon Hammer Screws	15

Hammers:	
Claw Hammer	97
Club Hammer	97
Sledge Hammer	97

Hearing Protection:	
Corded Ear Plugs	90
Dispensers	90
Disposable Ear Plugs	90
Earmuffs	90

Helical Fixings:	
Composite Panel Fixing	11
Insulation Fixings	11

Hexagon Keys	97
---------------------------	----

Holesaws:	
Arbors /Drive Adaptor with HSS Pilot Bit	56
HSS Bi-Metal Holesaws	56
HSS Pilot Bit	56

I

Impact Driver	35
----------------------------	----

Impact Wrench	38
----------------------------	----

Insulation Fixings:	
Frame Fixings	16
Helical Fixings	11
Insulation Hangers	16
Insulation Support DHK	16
Insulation Support DHM	16

J

Jigsaw	
Corded	45
Cordless	36

K

Knife Blades	101
---------------------------	-----

Knives:	
Fixed Blade Knife	100
Retractable Folding Knife	100
Retractable Trimming Knife	100
Safety Knife	100
Taping Knives	102
Trimming Knife – Snap Off	100
Trimming Knife Card	100

L

Ladders:	
Combi Ladders	107
Extension Ladder	110
Platforms	110
Podium	107
Step Ladders	108
Telescopic Ladder	110

Lubricating Oil	81
------------------------------	----

M

Machine Screws	9
Marking Out:	
Chalk Line & Chalk & Level.....	95
Combi Square.....	95
Plumb Bob.....	95
Material Transportation	111, 113 – 114
Mitre Saw:	
Corded.....	44
Cordless.....	36
Mixings Paddle	103
Multifix Bolts:	
Masonry Bolt.....	25
Multifix Screw	9
Multitool	38, 98
Multitool Accessories:	
Diamond-Riff Blade.....	62
Flooring Set.....	63
Plunge Cut Blade.....	62
Precision Plunge Cut Blade.....	63
Scraper.....	62
Segment Knife.....	62
Segment Saw Blade.....	63
Serrated Groove Cutter.....	62
Tiling Set.....	62
Universal Groove Cutter.....	63

N

Nailers:	
Brad Nailers.....	27
Cordless Gas Nailers.....	27
Gas Framing Nailers.....	27
Positive Placement Nailer.....	27
Nail Packs & Fuel Packs:	
Fuel Packs to Suit IM350.....	28
Fuel Packs to Suit IM360Ci.....	28
Fuel Packs to Suit IM65.....	29
Fuel Packs to Suit IM65A.....	29
Fuel Packs to Suit PPN35Ci.....	29
Pins to Suit Pulsa 800E.....	30
Pins to Suit Pulsa 800P+.....	30
Staple Fuel Packs Suit IM200.....	29
Nail Punch	97
Nails:	
Annular Ring.....	10
Clout Nails.....	11
ELH clout.....	10
Masonry Nails.....	11
Mickey Pins.....	11
Round Wire.....	10
Square Twist.....	10
Nibbler	43

P

Packers & Shims	12
Painting Accessories:	
Brushes.....	105
Paint Kettle.....	105
Roller Kit.....	105
Pallet Wrap	122
Percussion Drill	40
Pins:	
Panel Pins.....	12
Planer:	
Corded.....	46
Cordless.....	38
Plasterboard Fixings:	
Driva.....	15
Plasterers Tools:	
Float.....	103
Hawks.....	102
Mixing Paddle.....	103
Taping Knife.....	102
Trowels.....	102 – 103
Pliers	98
Plugs	15
Plunge Saw	45
Podium	107
Powertools – Corded:	
Angle Drill.....	40
Angle Grinder.....	42
Circular Saw.....	45
Cut Off Saw.....	43
Diamond Core.....	41
Die Grinder.....	42
Jigsaw.....	45
Mitre Saw.....	44
Nibbler.....	43
Percussion Drill.....	40
Planer.....	46
Plunge Saw.....	45
Reciprocating Saw.....	44
Rotary Drill.....	40
Router.....	46
Sander.....	46
SDS Max/Demolition Hammer.....	41
SDS/Rotary Hammer.....	41
Shear.....	42
Table Saw.....	44
Trimmer.....	46
Powertools – Cordless:	
Combination Drill.....	33
Circular Saw.....	36
Drill Driver.....	35
Drywall Autofeed.....	37
Grinder.....	37
Impact Driver.....	35
Impact Wrench.....	38

Jigsaw	36
Kits	39
Mitre Saw	36
Multi Tool	38
Planer	38
Radios	39
Reciprocating Saw	37
SDS/Rotary Hammer	33
Primers	81
Protection Board	120
Protection Film:	
Carpet	120
Glass	120
PVA	80

R

Racks:	
Portable	113 - 114
Radios	37
Reciprocating Saw:	
Corded	40
Cordless	37
Resin	25
Resin Studs	25
Rivets	20
Rotary Drill	40
Rotary Hammer:	
Corded	41
Cordless	33
Router	46
Router Cutters	59
Rubble Sacks	122

S

Safety Doors	119
Sander (Electric)	46
Sanding:	
Extention Pole	104
Hand Sander	104
Pole Sander	104
Sanding Belts	59
Sanding Sheets	60
Saw Blades:	
Circular Saw Blades	57
Diamond Blades	57
Jigsaw Blades	57
Reciprocating Saw Blades	57
Saws:	
Fine Finish Saw	99
Hacksaw	99
Hand Saw	99
Insulation Saw	99
Jabsaw	99
Tenon Saw	99

Screwdrivers:	
Ratchet Screwdriver	96
Screw Extractor Set	97
Screwdriver Sets	96 - 97

Screwdriver Bits:	
Bit Holder	58
Nut Driver	58
PH Phillips Bits	58
PZ Pozidrive Bits	58
TX Torx Bits	58

SDS Powertools:	
SDS Max/Demolition Hammer	41
SDS/Rotary Hammer (Corded)	41
SDS/Rotary Hammer (Cordless)	33

Sealants:	
Acoustic	68
Caulk	66
Fire	67 - 68
Mastic	66
Silicone	66 - 69
Waterproof	66 - 69

Sealant Guns:	
Foil Pack Applicator Gun	70
Sealant Gun	70

Security Screws	16
------------------------------	----

Shear	42
--------------------	----

Shot Fired Tools	28
-------------------------------	----

Shovels	105
----------------------	-----

Silicone Eater	68
-----------------------------	----

Site Protection:	
Flame Retardant Sheeting	121
Floor Protection	120 - 121
Glass Protection	120
Handrail Safety Posts	121
Protection Board	120
Stairtread Protectors	121
Zip Door Kits	121

Skirting Screws	19
------------------------------	----

Slitting Discs	61
-----------------------------	----

Spirit Levels	95
----------------------------	----

Spring Toggles	15
-----------------------------	----

Staplers:	
Gas Stapler	28
Heavy Duty	101
Staples	101
Tacker	101

Storage – Heavy Duty:	
Cutting Station	111
Chemical Storage	111, 116
Flammable Chemical Storage	112 - 113
Gas Cage	113, 117
High Security	116 - 117
Oil Drum Storage	112, 117
Pipe Storage	114
Power Station	114

Storage Bench.....	114
Tool Vaults.....	115
Walk In Storage Unit.....	117
Work Station.....	115

Storage – Medium Duty:

Carts.....	118
Portable.....	118
Tool Vaults.....	118

Stud Detector	105
----------------------------	-----

Superglue & Activators	77
---	----

T

Table Saw	44
------------------------	----

Tapcon	16
---------------------	----

Tape Measures	96
----------------------------	----

Tapes:

All Purpose Tape.....	83
Barrier Tape.....	84
Double Sided High/Low Tack Tape.....	83
Double Sided Tape.....	84
Drywall Tape.....	83
Easi-Peel Tape.....	83
Electrical Tape.....	84
Foil Tape.....	84
Gaffa Tape.....	83
Hazard Warning Tape.....	83
High Tack PVC Tape.....	83
Masking Tape.....	83
Packaging Tape.....	84
PTFE Tape.....	84

Taping Knife	102
---------------------------	-----

Tek Screws:

Composite Panel.....	17
Light Gauge.....	17
Sitching Screws.....	17
Timber Fix.....	17

Tool Storage:

Heavy Duty.....	115 – 117
-----------------	-----------

Trimmer	46
----------------------	----

Through Bolts	25
----------------------------	----

Trowels:

Brick Trowel.....	103
Bucket Trowel.....	102
External Corner Trowel.....	103
Gauging Trowel.....	103
Internal Corner Trowel.....	102
Plasterer's Finishing Trowel.....	102
Pointing Trowel.....	102

U

Utility Bar	99
--------------------------	----

W

White Spirit	81
---------------------------	----

Wire Hangers	17
---------------------------	----

Wood Screws:

Twin Thread Woodscrew.....	8
Multi-purpose Chipboard Screws.....	8

Workbench:

Portable.....	114 – 115
Folding.....	119

Workwear:

Disposable Workwear.....	87
Facemasks.....	89
Fleeces.....	87
Footwear.....	89
Gloves.....	91
Hi-Visibility Clothing.....	88
Knee Pads.....	88
Safety Glasses.....	88
Sweatshirts.....	87
T Shirts.....	87
Trousers.....	87
Waterproof Clothing.....	87

Wrench	99
---------------------	----

Did you know that we can also supply...



www.siginsulation.co.uk



www.sig-ca.co.uk



www.sigtechnicalinsulation.co.uk



www.siginteriors.co.uk



www.sigmechanicalelectrical.co.uk



www.sigpt.co.uk



SIG is committed to the health, safety and wellbeing of our employees, customers and the general public. We operate a zero harm policy and have gained accreditation to FORS at all of our operating sites.



For more information please visit:
www.sigassured.co.uk

For specialist advice and guidance on choosing the right fixings for your project, contact your local Technical Information centre today...

SIGD North - 0113 2451626

SIGD South - 0121 6653050

SIGD Scotland - 0141 6433616



Products are available from the following SIG branches:

SIG Fixings

Scotland

Glasgow 0141 643 3616

North East

Leeds 0113 245 1626

Tyneside 0191 482 7480

North West

Manchester 0161 969 8121

Birmingham 0121 541 4540

South East

Norwich 01603 411 022

South West & Central

Bristol 0117 931 3430

SIG Interiors

Scotland

Glasgow 0141 440 6960

North East

Leeds 0113 270 0333

Leicester 0116 255 1585

Nottingham 0115 944 1359

Sheffield 0114 231 7317

Tyneside 0191 482 4211

North West

Birmingham 0121 380 1600

Manchester 0161 874 5311

South East

Barking 0208 477 9500

Croydon 020 8684 7775

Edmonton 020 8884 3444

Maidstone 01622 791 100

Norwich 01603 765 660

Southwark 020 7064 4900

South West & Central

Bedford 01234 761 112

Bristol 0117 931 3432

Cardiff 029 2047 4787

Plymouth 01752 675 414

Oxford 01993 700 993

South West

Brighton 01903 755 876

Heathrow 01753 691 818

Lancing 01903 755 876

Luton 01582 594 222

Portsmouth 023 9269 6733

Southampton 023 8074 3799

Twickenham 020 8891 5971

SIG Insulation

Scotland

Aberdeen 01224 825 825

Eurocentral 01698 833 755

Inverness 01463 701 200

Stirling 01786 849 100

North East

Chesterfield 01246 450 505

Leeds 0113 385 7700

Leicester 0116 232 5019

Loughborough 01509 231 891

Sheffield 0114 241 3000

Tyneside 0191 226 3110

North West

Birmingham 0121 665 3050

Burton-on-Trent ^{SO} 01283 643 790

Coventry 02476 644 373

Leominster ^{SO} 01568 708 888

Manchester 0161 876 4776

South East

Barking 020 8477 9500

Colchester 01206 214 600

Maidstone 01732 370 500

Norwich 01603 765 660

Sidcup 020 8269 3939

Solent 023 8074 3946

South West & Central

Bedford 01234 761 100

Bridgwater ^{SO} 01278 686 000

Bristol 0117 931 3400

Cardiff 029 2066 2900

Oxford 01993 700 993

Plymouth 01752 675 400

South West

Brighton 01273 685 183

Heathrow 01753 689 200

Lancing 01903 755 876

Ruislip 020 8839 4321

Solent 023 8062 5550

Southampton 023 8074 0074

SIG Construction Accessories

Scotland

Aberdeen 01224 822 798

Glasgow 0141 445 3444

Inverness 01463 701 200

North East

Leeds 0113 385 7760

Nottingham 0115 934 6402

Tyneside 0191 487 4983

North West

Birmingham 0121 522 0200

Manchester 0161 872 5464

South East

Norwich 01603 224 899

Thurrock 020 8591 9991

South West & Central

Bedford 01234 268 427

Bristol 0117 979 8396

Cardiff 02920 465 553

Oxford 01993 700 993

Plymouth 01752 894 965

South West

Ash Vale 01252 527 000

Ruislip 020 8839 2656

SIG Technical Insulation

Scotland

Aberdeen 01224 771 566

Glasgow 0141 643 3600

North East

Chesterfield 01246 269 537

Leeds 0113 385 7777

Leicester 0116 232 5000

Tyneside 0191 226 6730

North West

Birmingham 0121 665 3050

Manchester 0161 836 4401

South East

Barking 020 7473 9310

Norwich 01603 226 005

South West & Central

Bristol 0117 931 3420

Oxford 01993 700 993

Plymouth 01752 675 417

Swansea 01792 588 461

South West

Portsmouth 023 9269 6733

Ruislip 020 8839 4290